



OFFICIAL BANK DETAILS

A/c Name : **EMIRATES BLOODSTOCK**
Bank : **Dubai Islamic Bank**
Branch : **Sheikh Zayed Road**
City / Country : **D U B A I - U . A . E**
A/c Number : **016 520 1496 344 01**
Swift Code : **D U I B A E A D X X X**
IBAN Number : **AE87 0240 0165 2014 9634 401**
Currency : **U.A.E Dirham**
Account Type : **Current Account**

Contact :

EMIRATES BLOODSTOCK

Mobile: +971 55 217 2121, Off.: +971 4 327 10 10

info@emiratesbs.com

www.emiratesbs.com

شروط المزاد

❖ الإمارات لمزاد الخيل هي السلطة المنظمة للمزاد
❖ قلعة الرمال هو المكان الرسمي لتنظيم المزاد

- يجب مراعاة الشروط والتعليمات التالية:
 1. أن لا يقل عمر المشترك عن 18 سنة
 2. يجب تعبئة وتوقيع نموذج التسجيل الخاص بالمزاد والمتوفر لدى الإمارات لمزاد الخيل
 3. إيداع مبلغ 10,000 درهم نقداً فقط
 4. علماً بأن رقم المزايدة معد للاستخدام الشخصي فقط، ويتحمل المشتري المعتمد كافة المشتريات المرساة على رقم المزايدة الخاصة به.
 5. يتم إسترداد مبلغ الإيداع خلال ثلاثة أيام من إتمام إجراءات البيع.
- يسترد الإيداع بالكامل في حالة عدم الشراء أو تتم تسويته مقابل أي سعر شراء أو أتعاب أخرى.
- تقبل المزايدات فقط من المشاركين المسجلين فالمزاد، الحاملين لأرقام المزايدة.
- يتم دفع قيمة الشراء والرسوم الإمارات لمزاد الخيل كاملاً خلال 7 أيام من إتمام إجراءات البيع.
- في حال تخلف المشتري عن دفع القيمة كاملة خلال المدة المدونة يعتبر البيع ملغياً وترد ملكية الخيل الى صاحبه الأصلي حيث يسقط حق المشتري في المبلغ الذي قام بإيداعه.
- يجب أن تعود جميع الخيول الى أسطبلاتها الأصلية بعد الإنتهاء من المزايدة عليها.
- في حال حدوث أي نزاع يتم تحكيم الإمارات لمزاد الخيل في ذلك النزاع ويكون القرار نهائياً و ملزماً لجميع الأطراف.

TERMS & CONDITIONS OF THE SALE

- The **EMIRATES BLOODSTOCK** is the official sale authority.
- The Official venue will be at **QALAAAT AL REMAAL EVENTS**.
- Each Prospective Buyer Must:
 - 1 – **18 years old**.
 - 2 – A Complete and sign a Bidding Registration Form supplied by **EMIRATES BLOODSTOCK**.
 - 3 – A Deposit of sum **AED 10,000 "CASH only"**.
 - 4 – Each Bidding Number is for personal use only. The prospective Purchaser will be personally responsible for all purchase.
 - 5 – The deposited amount will return within three working days from the sale.
- The Bids only accepted from registered bidders who own the "**Bidding Numbers**".
- Each lot became the property of the highest bidder at the fall of the auctioneer's hammer.
- A sale conducted on a "**Buyers Beware**" principle with no guarantees on any purchase.
- Full payment will be settled of the purchase price to **EMIRATES BLOODSTOCK** within **SEVEN days** from the sale.
- If the Purchaser fails to make full payment by this time, the sale will be considered null and void, and the prospective Purchaser's deposit will be forfeited.
- The amount shall be by **CASH** or **Bank Transfer** to **EMIRATES BLOODSTOCK**.
- The Purchaser shall present the **Horse Collection Form** to the official stable representative during the horse collection.
- In the case of any dispute related to any matter concerning this sale, the Auction Committee's decision shall be final and binding on all the parties.

No:01

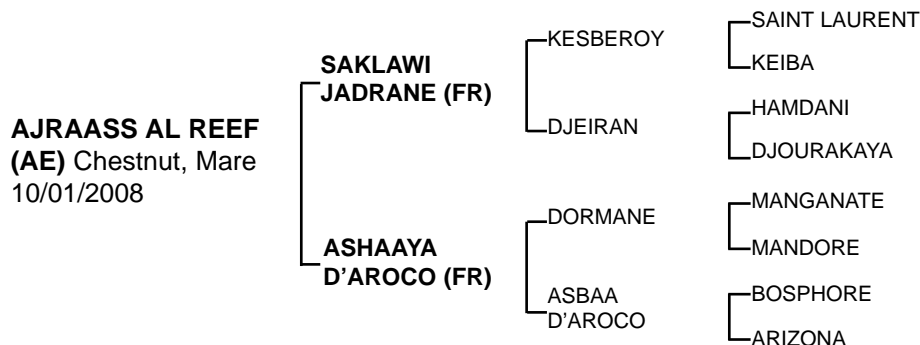

AJRAASS AL REEF - 2 places from 3 starts.

Sire: **SAKLAWI JADRANE** (c, Kesberoy), 8 wins and 4 places from 12 start, incl: **1st Prix du President des E.A.U.- Challenge Derby (G1), Coupe d'Europe et des E.A.U. (Gr1), La Coupe d'Al Asayl Management (Gr2), La Coupe d'Al Asayl Management (Gr3), Al Makatoum Challenge R2 (Gr1), Al Makatoum Challenge R3(Gr1)**. and Sire of many winners incl: **AF MURSID** - 2 wins and placed 7 times at 4 and 5 years in U.A.E.; **KING** - 1 win at 4 years.; **MUJTAHID** - 2wins and placed once at 4 and 5 years, **MUDALLAL AL REEF** - 3 wins & 4 places, **EIZ AL REEF** - 2 wins & 6 places, **HADY** - 1 win & placed from 2 starts, incl: 4th Coupe de France des Chevaux Arabes (Gr.1) & many others.

1st Dam: **ASHAAYA D'AROCO** (f, by Dormane) 3 wins & 8 places, HH Sh. Khalifa bin Zayed Al Nahyan Triple Crown R2 (Gr.3), 2nd The President Cup (Gr.1), Dam of: **AMEER AL REEF** (c, by Bibi De Carrere) 4 wins & 16 places.

2nd Dam: **ASBAA D'AROCO** (f, by Bosphore) unraced, Dam of:

AL JAC D'AROCO (c, by Munjiz) 2 wins & 4 places

AMSARA D'AROCO (f, by Dormane) 6 wins & 9 places, French Arabian Breeder's Cup (Gr.1), 2nd Prix d'Abu Dhabi (Gr.1). Dam of:

GHOBAT BAHAR (f, by Amer) 1 win & 9 places

AL SARDAL (c, by AF Albahar) 1 win & 2 places

ADJINN D'AROCO (f, by Tidjani) 3 wins & 8 places - Hawthorn Hill Int'l Stakes (Gr.2), 3rd The Dubai Int'l Stakes (Gr.1), Prix Manganate (Gr.1)

ARAKHAN D'AROCO (c, by Dormane) 1 win & 6 places

ASHAM D'AROCO (c, by Dormane) 1 win & 3 places

ABAJDARA D'AROCO (f, by Dormane) 1 win & 6 places

ASMAN D'AROCO (c, by Manganate) 1 win & 5 places

ALTESSE D'AROCO (f, by Mangnate) 3 wins & once 4th place from 4 start, incl: Prix Des Emirates Arabes Unis Equestrian & Racing Federation. Dam of:

AL NAQA (f, by Amer) 5 wins & 10 places, 2nd The Hatta Int'l Stakes (Gr.1)

HAJAJ (c, by Djebbel) 8 wins & 5 places

AL TAIR (c, by Amer) 8 wins & 4 places, Prix Manganate (Gr.1), Qatar Cup (Gr.2), Prix Dragon (Gr.2)

TABARAK (c, by Nizam) 13 wins & 5 places, H.H. The Emir Sword (Gr.1), H.H. The Heir Apparent Int'l Trophy (Gr.2), Derby Trial (Gr.2), Sh. Abdulla bin Khalifa Al Thani Cup (Gr.3), Guineas (Gr.3).

No:02

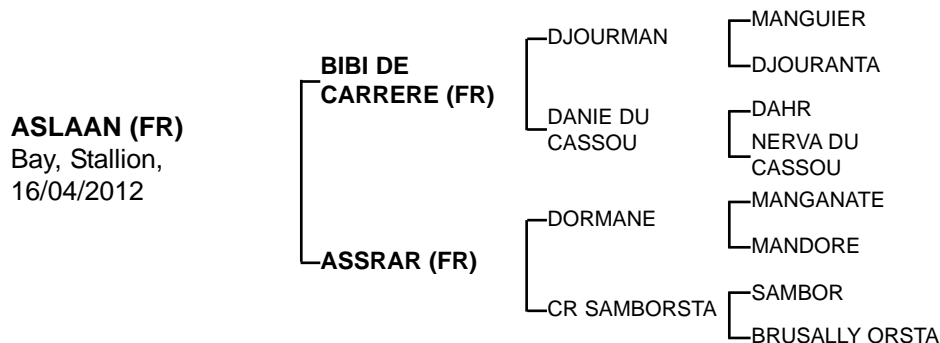
**ASLAAN - 4 wins & 10 places. Official Rating: 60**

Sire:**BIBI DE CARRERE** (c, by Djourman) **8 wins** and 6 places from 17 starts at 3- 5yo in France & UAE, Sire of **many winners** incl: **RABBAH DE CARRERE - 5 wins** & 5 places, **DYNAMITE - 10 wins** & 23 places - The First Local bred in the History of Arabian Racing to winner of HH The President Cup (Gr.1), **NAHEE - 4 wins** & 4 places, **CARAT - 4 wins** & 8 places, **SHA'RED - 2 wins** & 5 places, **MARZOOQ - 2 wins** & 1 place, **RS KERIM - 6 wins** & 3 places, **SAKEN - 8 wins** & 6 places & among others.

1st Dam: **ASSRAR** (f, by Dormane) **2 wins** & 1 place from 3 starts. Dam of:
BASEEL (f, by Munjiz) **3 wins** & 1 placed from 4 starts in France. incl: Prix Nevada II (Gr.3), Prix Razzia III (Gr.3), 3rd Qatar Arabian Trophy des Pouliches (Gr.1).

HAMARES (c, by Bibi De Carrere) **2 wins** & 11 places.

2nd Dam: **CR SAMBORSTA** (f, by Sambor) **7 wins** & 3 places from 11 starts, Incl:
1st AJC Debutante Handicap, AJC Delaware Stakes, Delaware Arabian Cup Juvenile Fillies, Fire Cracker Futurity VI, Korona Arabian Cup Juvenile Fillies, 2nd AJC California Stakes, Dam of **winners** incl:

SABEAR (f, by Dormane) **5 wins** & 14 places

SARRAB (c, by Tidjani) **9 wins** & 12 places

DARIYA (c, by Dormane) **8 wins** & 8 places

SAHER (g, by Tornado de Syrah) **2 wins** & 7 places

SAHLAMBO (f, by Munjiz) **7 wins** & 6 places

SYRIANAH (f, by Dormane) **3 wins** & 8 places

SAMJIDA (f, by Majd Al Arab) **2 wins** & 5 places

HERCEY SEINE (c, by Majd Al Arab) **1 win** & 1 place from 3 starts.

MANNAR (f, by Djelfor) unraced. Dam of:

MARAM (c, by Nez d'Or) **3 wins** & 8 places

Shahranaz (f, by Scharly) unraced, Dam of:

MUSHAIRIB (c, by Calin du Loup) **1 win** & 5 places from 7 starts.

No:03

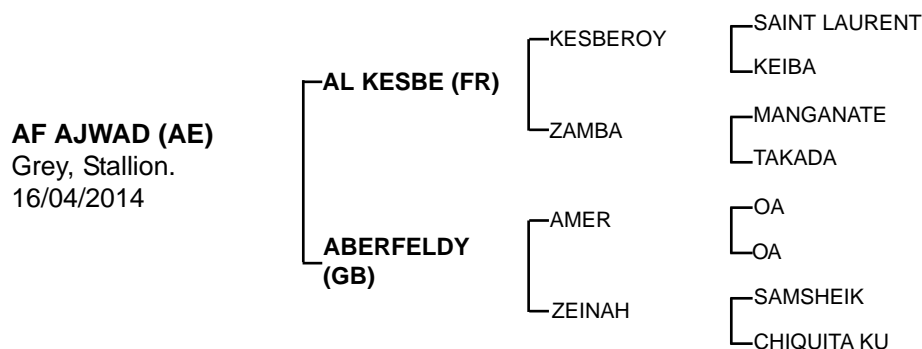
**AF AJWAD - 1 win & 4 places in UAE, Official Rating: 40**

Sire: **AL KESBE** (c, by Kesberoy) **6 wins** & 15 places from 25 starts, **winning incl:** **1st** Nakeel Challenge Cup, **1st** Liwa Oasis (Gr.1), **1st** Sir Bu Nuair, **1st** Int'l Petroleum Investment Company.. **Half Brother** to **GHALIT AL KHALEDIAH** - **2 wins** & 5 places, **AL DJERBY** - **3 wins** & 6 places. His sire **KESBEROY** (c, by Saint Laurent) - **won** once at 3 in France, Leading sire of Gr.1 performers in France, UK & UAE incl **dual Gr.1 Dubai Stakes winner NO RISK AL MAURY**, **dual Gr.1 Dubai Stakes & Gr.1 Coupe de Europe winner AL SAKBE**, **NACREE AL MAURY**, **BRAISE DE GHAZAL**, **KERRA**, **VIRGULE AL MAURY**, **KERBELLA**, **NOUBA AL MAURY** - **won Gr.1 Hatta Stakes**, **NEVADOUR AL MAURY** - **won Gr.1 Coupe de Europe**, **DJELFEE**, **SAKLAWI JADRANE**, **HATCHEPSOUT**, **KESBAH**, **MUNJIZ**, **KANDAR DE FALGAS** - **won Gr.1 Abu Dhabi Juvenile Championship UK**, **AL KESBE**, **CHARTHAGENNA**, Sire of **Multiple UK winner HELLOW**, **WAY WARD FEARY** & **WAYWOOD TWISTER**.

1st Dam: **ABERFELDY** (f, by Amer) **4 wins** & 11 places, incl: **1st** Liwa Oasis (Gr.1), Dam of:

AF TAHOONAH (f, by AF Alsalam) **1 win** & 1 placed from 3 starts.
AF AJWAD (c, by Al Kesbe) **Subject Horse**.

2nd Dam: **ZEINAH** (f, by Samsheik) unraced, Dam of:

MISS MONCRIEFF (f, by Makzan) **1 win** & 12 places
Dunollie (f, by Djebbel) 2 places from 2 starts

3rd Dam: **CHIQUITA KU** (f, by SX Champion) unplaced, **FULL SISTER** to **ANNATIKI** - **6 wins** & 16 places (3rd Delaware Arabian Cup Distaff (Gr.2), Town & Country ECRA Distaff (Gr.3)). **CHIQUITA KU** Dam of:

CR Valerie (f, by Charlie Valentine) unplaced from 1 start. Dam of:
VALET MAN (g, by Tomanchie) **1 win** & 10 places.

No:04

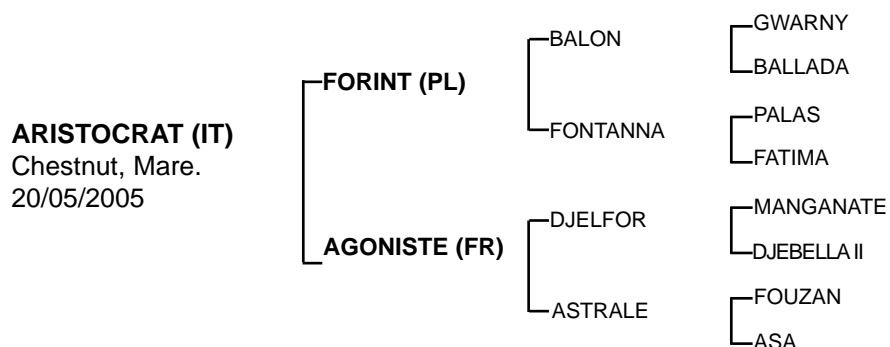

Sire: **FORINT** (c, by Balon) **Europa Cup Winner**.

1st Dam: **AGONISTE** (f, by Djelfor) 2 wins from 2 starts. Her sire **DJELFOR** (c, by Manganate) Best 3 year old in France, **7(5-2-0)**, he is proving himself as a sire the highest Class. His stock includes **CALIN DE LOUVE (won 8 races in USA)**, **BAR ROYAL NEWDAY**, **NE RIEN PRENDRE**, **KAIROUAN DE JOS**, **VERLIZE**, **FEHRA**, **DJEBBEL** and **AKBAR**, the best of their generations in many countries from the USA to UAE. **DJELFOR** is certainly one of the best sons of the great **MANGANATE**.

2nd Dam: **ASTRALE** (f, by Fouzan) 5 places from 7 starts, Dam of:

AVENTURIER (c, by Djelfor) 1 win & 12 places

ARIOSO (c, by Djov La Jarthe) 1 win 7 6 places

Altiere (f, by Djouran) unplaced, Dam of **winners** incl:

ALTO DE MALIGNÉ (c, by Djelfor) **5 wins & 10 places** - 3rd AL Nahyan Triple Crown RIII (**Gr.2**) - Sire

AI Din (f, by Djelfor) unraced, Dam of **winner**:

ALIZE SAFINAT (c, by Tidjani) **3 wins & 9 places**

Alebarde (f, by Bardo) unraced, Dam of **winner**:

MALIK DU POUY (c, by Darike) **1 win & 6 places**

ALBANY (f, by Dunixi) **3 wins & 2 places**. **winner** of Prix Arabian Speed, 3rd The Hatta Int' Stakes (**Gr.1**). Dam of **winners** incl:

ANASTASYA (f, by Dormane) **3 wins & 8 places**. **winner** of: French Arabian Breeder's Cup (**Gr.1**), Abu Dhabi Int' Champion (**Gr.1**), 2nd Prix du Pdt des UAE (**Gr.1**), 2nd Razzia III (**Gr.3**), 3rd Coupe d'Europe (**Gr.1**). Dam of **winner** incl:

DUBAI HEROS (c, by Amer) 2 wins & 3 places

ARKADYA (c, by Dormane) **1 win & once 5th place** in France & UAE.

winner of Prix du Haras D'Uzes. Dam of **winner** incl:

MH AL WADI (c, by Zefiro de Nulvi) **4 wins & 8 places**.

No:05

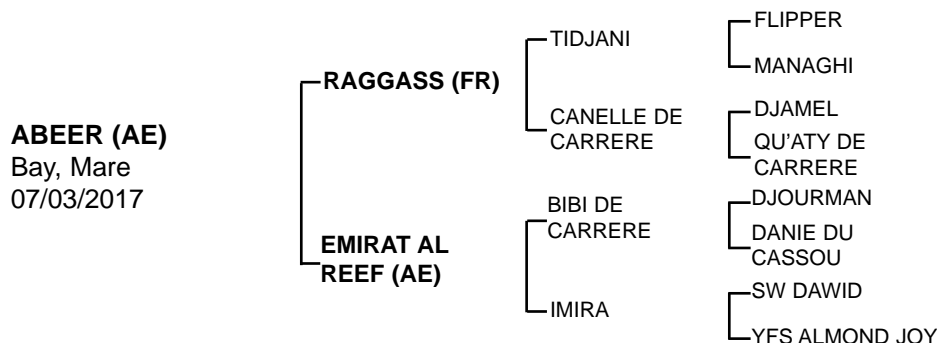

ABEER - unplaced. **Official Rating: 40**

Sire: **RAGGASS** (c, by Tidjani) **4 wins** & 5 places in UAE, incl: 3rd HH The President Cup (**Gr.1**), 3rd Mazrat Al Ruwayyah (**Gr.2**). His sire **TIDJANI** (c, by Flipper) **won 5 races** at 3 years from 5 starts **winning** including La Teste, Prix Kristine, Pompadour, Prix Dahman, Pompadour and Prix Massoud, Pompadour; leading sire of **winners** including **DJANIZID, ELIXIR DE BASTORRE, MASSAMARIE, ALA CROIXNOIRE, TAHAAR DE CANDELON, CARLOTTA DU PAON, CATIDJA, MAFATAMA** & among others.

1st Dam: **EMIRAT AL REEF** (f, by **BIBI DE CARRERE** (c, by Djourman) **8 wins** and 6 places from 17 starts at 3- 5yo in France & UAE, Sire of **many winners** incl: **RABBAH DE CARRERE - 5 wins** & 5 places, **DYNAMITE - 10 wins** & 23 places - The First Local bred in the History of Arabian Racing to winner of HH The President Cup (**Gr.1**), **NAHEE - 4 wins** & 4 places, **CARAT - 4 wins** & 8 places, **SHA'RED - 2 wins** & 5 places, **MARZOOQ - 2 wins** & 1 place, **RS KERIM - 6 wins** & 3 places, **SAKEN - 8 wins** & 6 places & among others).

1st Dam: **IMIRA** (f, by SW Dawid) once 4th place in UAE. Her sire **SW DAWID** (c, by Etiw) a **Halter Champion** and sire of **many stakes winners**.

2nd Dam: **YFS ALMOND JOY** (f, by YF El Damir) unraced, Dam of **winners** incl: **JOYZELL (MAHA)** (f, by Jaf Orphatyn) **Sprint Champion, Highest Race record** in USA & UAE. **29 wins** from 29 races since 3yo to 10yo. **Champion** in UAE **25 wins** for 25 races, **Top Rating - 140**. World record 1000m record - Abu Dhabi: 1.02:06 & 1200m record - Abu Dhabi: 1.16:67..Dam of:

LAHAB (c, by Tahar de Candelon) **3 wins** & 6 places in UAE,

MAHABB (c, by Tahar de Candelon) **5 wins** and 3 places for 8 races 4 & 5yo in France & England - **Sire**

JUSTAJOYY (c, by Brusally Orlen) **1 win** & 4 places from 6 starts in USA

Justonetime (f, by Brusally Orlen) Unraced, Dam of **winner's** incl:

NO REPEAT (c, by Wiking) **2 wins** & 9 places in USA

IN SINGLE (f, by Wiking) **1 win** & 5 places in USA

ONE OF US (c, by Vadeer) **4 wins** & 5 places in USA

ONCET (g, by Tomanchie) **3 wins** & 7 places in USA

Sarha (f, by T C Tomtyr) Unraced, Dam of **winner** incl:

FILSD CROIXNOIRE (c, by Ala Croixnoire) **3 wins** & 10 places

NARAA (f, by Calin de Louve) **1 win** & once 2nd from 2 starts

DIRHAM EXPRESS (f, by TC Tomtyr) **2 wins** & 10 places in USA.

No:06

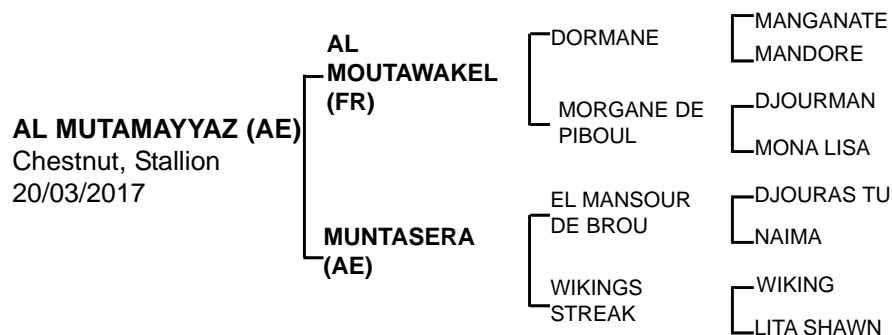

Sire: **AL MOUTAWAKEL** (c, by Dormane) **6 wins** & 13 places in Qatar, UK & UAE, incl: **1st** Al Maktoum Challenge R2 (**Gr.1**), H.H. Sh Khalifa bin Zayed Al Nahyan Triple Crown R3 (**Gr.3**), DATEL H.H. Sh. Khalifa bin Zayed Al Nahyan R2 (**Gr.3**), 2nd The Qatar International Stakes (**Gr.2**), 3rd Dubai Kahayla Classic (**Gr.1**), Al Maktoum Challenge R3 (**Gr.1**), **Half Brother** to **AL SAKBE** (c, by Kesberoy) **11 wins** & 7 places - **Sire, AL MOUWAFFAK** (c, by Azadi) **4 wins** & 8 places - Qatar Total Arabian trophy des Poulains (**Gr.1**), **AL MOUTTAKEL** (c, by Djebbel) **2 wins** & 9 places, **AL MANNSOUB** (g, by Akbar) **4 wins** & 6 places, **AL MANZOOM** (c, by Nizam) **1 win** & 3 places, **AL MANSSOUBA** (f, by Amer) **1 win** & 6 places.

1st Dam: **MUNTASERA** (f, by El Mansour de Brou) unplaced from 1 start. Her sire **EL MANSOUR DE BROU** (c, by Djouras Tu) **7 wins** & 8 places. **Track Record:** NAD AL SHEBA 1700mtr in 1:54:73 (07/01/1999) **winning** incl: **1st** Prix Dehram (pampadour- 1700m), **1st** Prix du 7EME SPAHIS (Montauban- 1500m), 2nd Sh. Maktoum Bin Rashid Challenge Round II (nad al Sheba -2400m), 2nd shadwell Stud- unfuwain Race (Nad Al Sheba-1800m)

2nd Dam: **WIKINGS STREAK** (f, by Wiking) **7 wins** & 18 places in UAE. Dam of: **WAFAYT** (c, by Dormane) **1 win** & 5 places
Shoagh (f, by Dormane) unraced, Dam of **winners** incl:
AIN JALOOT (c, by Amer) **7 wins** & 10 places
SOODH (f, by Djebel Lotois) **1 win** & 3rd (twice) from 4 starts.
EARLY MORNING (f, by Johnny Onthe Spot) **1 win** & 3 time 3rd place.

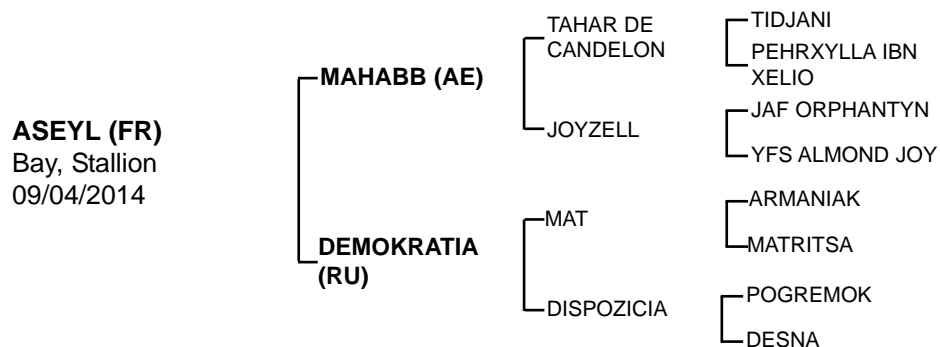
No:07

ASEYL - 4 places in UAE, **Official Rating: 40.**

Sire: **MAHABB** (c, by Tahar de Candelon) 8 races, **5 wins & 3 places** at 4-5 in France & England - **\$41,071**, winning incl: **1st Prix Nefta (Gr.2)**, **1st Prix Damas (Gr.3)**, 2nd The Zaabeel International Stakes (**Gr.1**)(**X2**), 3rd French Arabian Breeder's Cup Mile (**Gr.1**) - **1200mtr record 1:16**, Sire of **many winners** incl: **MANARK, FAZAH, SARDAN, REKHA, MESTOR, AREEM SHATEH, AF HASBA, AF TATHOOR, TAYMOUR, JOORI, AF MO'ASSESS, ROCKMANE, SAUTERNES AL MAURY, MEYDAN DU PAON, THAKIF, CHALWA DU PAON, SHAHM, NASEEM, VISIONARY LADY** & many more.

1st Dam: **DEMOKRATIA** (f, by Mat) 2 places from 3 starts in Russia. Dam of:
BASSAAM (g, by Munjiz) 1 win & 3 places in UAE

2nd Dam: **DISPOZICIA** (f, by Pogremok) once 2nd placed in Russia.

3rd Dam: DESNA (f, by Kumir) winner in Russian, Dam of:
DIAGONAL (f, by Gusar) **2 wins & 5 places** in Russia, incl: **winner** of Autumn Stakes (**Gr.3**).

No:08

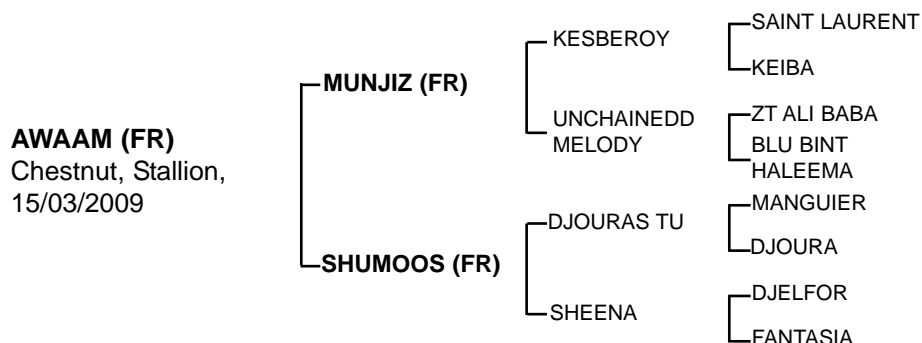

AWAAM - 2 places from 4 starts. Official Rating:75

Sire: **MUNJIZ** (c, by Kesberoy) **1 win** & 4 places from 6 starts. **winner** of: Prix du President des Emirats Arabes Unis - Challenge Derby (**Gr.1**), 2nd Prix de Carthage (**Gr.2**), 3rd Prix du Haras de Gelos. **Half brother** to **MIZZNA**, **MIJDADD**. Sire of **winners** incl: **JOSCO DU CAUROU**, **GHALIB**, **SAHLAMBO**, **MUNZADE**, **MYRA DE MONLAU**, **AAKIF**, **AL MAMUN MONLAU**, **AWAM**, **ELYAAH**, **AL BASHTOON**, **MISTER DU LOUP**, **MELK**, **FANTASY MISS**, **LADY WISH**, **MISS FANTASIA**, **MASCATE**, **GHADEER**, **KARLOS DU CAYROU**, **ZAKHO**, **THABIT**, **BANDAR**, **NAJAH**, **YATHRIB**, **MUNOWRA**, **AUSTRALYA**, **SOMOUD**, **ESKANDAR**, **BASEEL**, **DUZAR**, **MUNZADE**, **CANDAHAR**, **MUSHARAF** & many more.

1st Dam: **SHUMOOS** (f, by Djouras Tu) **1 win** & 10 places in France, Dam of:
AOUN (c, by Mahabb) **5 wins** & 13 places, incl: Prix Tidjani (**Gr.3**), Prix The President of the UAE Cup (**L.PA**).
SUFYAN (c, by Munijiz) **2 wins** & 3 places
HAMMSA (f, by Sarrab) **1 win** & 2 places
AJJAJ (c, by Tahar De Candelon) **5 wins** & 15 places
HAAJEB (c, by Mawood) **3 wins** & 17 places, incl: Al Maktoum Challenge R2 (**Gr.1**), 4th Bani Yas (**Gr.2**).

2nd Dam: **SHEENA** (f, by Djelfor) **5 wins** & 12 places in UAE. Dam of:
SHADIYDA (c, by Al Sakbe) **8 wins** & 11 places, incl; Abu Dhabi Championship (**Gr.1**), French Arabian Breeder's Cup (**Gr.1**), Emirates Championship (**Gr.1**), Sh. Khalifa Triple Crown R2 (**Gr.3**).
RAAZIQ (c, by Munjiz) **4 wins** & 5 places, incl; Al Maktoum Challenge R3 (**Gr.1**), 2nd Al Maktoum Challenge R2 (**Gr.1**), Al Maktoum Challenge R1 (**Gr.1**), 3rd Dubai Kahayla Classic (**Gr.1**).
THAKIF (c, by Mahabb) **7 wins** & 19 places, incl: National Day Cup (**Gr.1**), H.H. The President Cup (**Gr.1**), Sh. Zayed Bin Sultan Al Nahyan Cup (**Gr.3**), Al Ruwais (**Gr.3**).
RAKED (c, by Magic De Piboul) **3 wins** & 9 places, incl: 2nd Emirates Championship (**Gr.1**), 3rd The President of the UAE Cup (**Gr.1**).
BIBISHEENA (f, by Bibi De Carrere) **2 wins** & 7 places
RAHEF (c, by Kerbella) 3 places from 4 starts, incl: 2nd Prix Cheri Bibi (**Gr.2**), Prix Tidjani (**Gr.3**).
SHAMMAR (c, by Bibi De Carrere) **1 win** & once 3rd placed.
Shimaal (f, by Sire D'Albret) 4 places from 5 starts. Dam of:
NAYROUZ (f, by Munjiz) **1 win** & 10 places.

No:09

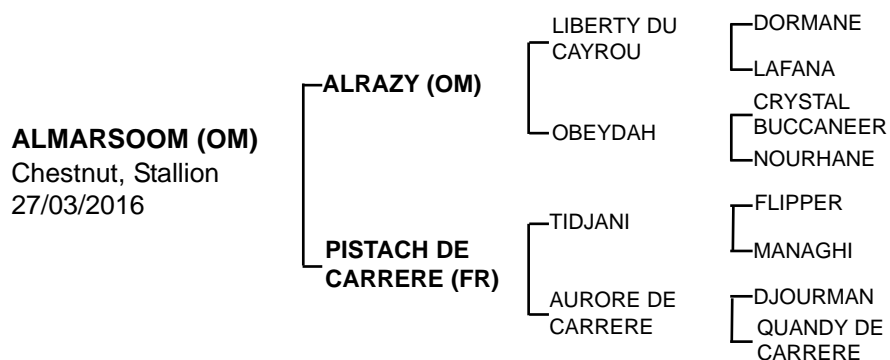

Sire: **ALRAZY** (c, by Liberty Du Cayrou) once 2nd placed from 5 starts in Oman, His sire **LIBERTY DU CAYROU** (Dormane X Lafana) **1 win & 5 places**.

1st Dam: **PSTACH DE CARRERE** (f, by **TIDJANI** (c, by Flipper) **won 5 races** at 3 years from 5 starts **winning** including La Teste, Prix Kristine, Pompadour, Prix Dahman, Pompadour and Prix Massoud, Pompadour; leading sire of **winners** including **DJANIZID, ELIXIR DE BASTORRE, MASSAMARIE, TAHAR DE CANDELON, CARLOTTA DU PAON, CATIDJA, ALA CROXINOIRE, MAFATAMA & among others**).

2nd Dam: **AUORE DE CARRERE** (f, by Djourman) unplaced from 1 start. Dam of:
GEGE DE CARRERE (Racing Name **ITTR AL WARD**) (f, by Royal De Carrere) **1 win & 2 places**
HAZIZ DE CARRERE (Racing Name **AL SAHAM AL FUDDI**) **7 wins & 11 places**.

3rd Dam: **QUANDY DE CARRERE** (f, by Elaborat) Unraced, Dam of:
FATIRA DE CARRERE (f, by Djamel) **3 wins & 3 places**, Dam of:
SNF MAHER (c, by Tahar De Candelon) **4 wins & 7 places**
GRP TAKTEEK GHANTOOT (c, by Drug) **1 win & 3 places**
EDEN DE CARRERE (c, by Manganate) **1 win & 5 places**
Cook de Carrere (f, by Bosphore) Unplaced, Dam of:
HAKIM DU BAC (c, by Manganate) **6 wins & 10 places**
Uxane de Carrere (f, by Passem) Unplaced, Dam of:
GHZALA DU BAC (f, by Royal de Carrere) **3 wins & 4 places**
HABIBA DU BAC (f, by Royal de Carrere) **1 win** from 1 starts
IUXA DU BAC (f, by Manganate) **1 win** from 1 starts. Dam of:
BH ALMOZIEG (c, by Burning Sand) **1 win & 2 places**.

No:10

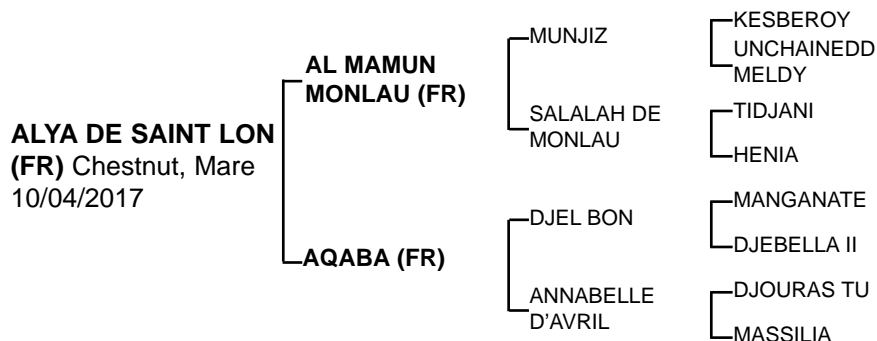

ALYA DE SAINT LON - unplaced from 3 starts,

INFOAL from MISTER GINOUX
(Amer X Nacree Al Maury by KESBEROY)

Sire: **AL MAMUN MONLAU** (c, by Munjiz) 5 wins & 9 places, 1st Dubai Kahayla Classic (Gr.1), Qatar Total Arabian Trophy (Gr.1), The President of The UAE Cup (Gr.1), Coupe du Sud Ouest Des Pur Sang Arabes (Gr.3), 2nd Qatar Cup - Prix Dragon (Gr.2), 3rd Qatar Coupe de France des Chevaux Arabes (Gr.1). Sire of **UM TAJ** - 1 win and 5 times placed incl. runner-up of **Gr.1PA** Al Rayyan Cup at Deauville, **Gr.2PA** Shadwell Criterium des Pouliches and **Gr.3PA** Prix Razzia II, **AJAWEED** - 1 win and 5 times placed, runner-up of **Gr.3PA** Prix Nevada II at Toulouse, **JUGURTHA DE MONLAU** - 1 win and 4 times placed incl. runner-up **Gr.1PA** President of the UAE Cup-UK Derby at Doncaster, **SNAN**, **JABIR**, **AL HAZM**, **JABALAH**, **SIR MONLAU**, **ANTAR**, **AMEL** & many more.

1st Dam: **AQABA** (f, by Djel Bon) unplaced from 2 starts in France. Dam of:
AYANE (f, by Parador) 2 wins & 3 places in Morocco
ALMA DE SAINT LON (f, by Asraa Min Albarq) 2 wins & 4 places in Morocco.
ADI DE SAINT LON (c, by Al Saoudi) 11 wins & 17 places in Morocco, 1st Sh. Zayed Bin Sultan Al Nahyan Cup.
AIDA DE SAINT LON (f, by Azadi) 5 wins & 20 places in Morocco.
AUTZA (f, by Jaman) 10 wins & 15 places
AIDA DE SAINT LON (f, by Azadi) 3 wins & 11 places
ALIZE (c, by Azadi) 1 win & 6 places in France & UAE.
AZIDA (f, by Azadi) 2 wins & 8 places.

2nd Dam: **ANNABELLE D'ACRIL** (f, by Djouras Tu) unraced, Dam of:
ABYANEH (c, by Darike) 1 win & 7 places
ALADIN LA NUIT (c, by Nuits St Georges) 1 win & 4 places

3rd Dam: **MASSILIA** (f, by Badr Bedur) unraced, Dam of:
Alfa De St Lon (f, by Djouras Tu) unraced, Dam of :
MOSHAKIS (g, by Tidjani) 1 win & 6 places
MUNIKI (c, by Tidjani) 1 win & 7 places
Keheilan (f, by Kesberoy) 6 places. Dam of winners incl:
AGHAREED AL KHALEDIAH (f, by Jalood Al Khalediah) 1 win
GHADAN AL KHALEDIAH (c, by Jalood Al Khalediah) 2 wins
BASEQ AL KHALEDIAH (c, by Tiwaiq) 1 win & once 2nd place.

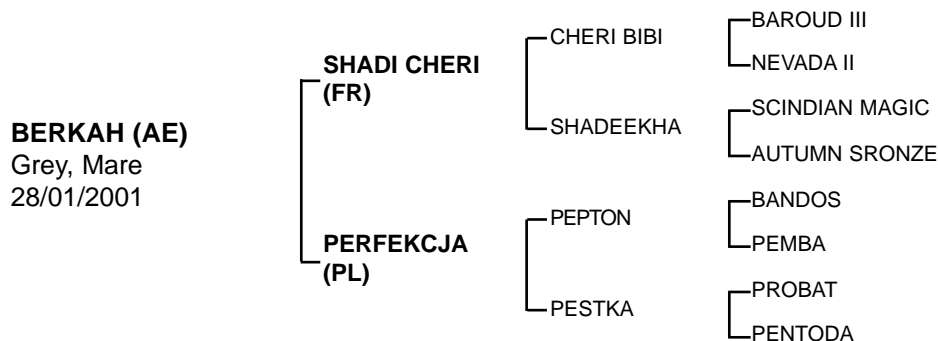
No:11

Sire: **SHADI CHERI** (c, by Cheri Bibi) **2 wins** & 3 places in France & UAE. Prix Freresic Bouas, **Half Brother** to **HAL MAUZY GARGASSAN** - **1 win** & 3 places, **KALHAN** - **1 win** & 7 places.

1st Dam: **PERFEKCJA** (f, by Pepton) **winner of 4 races**, 2nd in Oaks, Dam of:

PERUS (c, by Pasat) **5 wins** & 13 places.

Her sire **PEPTON - 80-81 2/16(11-4-0-1) winner 9 Stakes races** incl: **Criterion** and **Produceis the classic Arabian**, the combination of both beauty and stamina - attributes which produced the incomparable race record of **winning 11 stakes races** and being named **Polish National Champion Stallion in 1989**. **Pepton** was one of the chief progenitors of the **Ibrahim** line in Poland, originated through Negatiw and then **Pepton's** sire **Bandos**. **Pepton** as a sire has created a lasting impact in Poland, first as the leading producer of **stakes winning** race horses and the **1984 Polish Reserve National Champion Stallion**.

2nd Dam: **PESTKA** (f, by Probat) unraced, Dam of **winner** incl:

PERLIK (c, by Pepton) **3 wins** & 13 places - Sire

PERSPEKTYWA (f, by Eukaliptus) **2 wins** & 6 places. Dam of:

PRINCE KALIPO (c, by MVA Prince Vayu) **2 wins** & 34 places

PERYS (g, by FS Bengali) **1 win** & 2 places

PIELGRZYM (c, by Gazal Al Shaqab) **1 win** & 1 placed

PEPESZA (f, by Eukaliptus) **2 wins** & 10 places, Dam of:

PERNILA (f, by Gazal Al Shaqab) **1 win** & 4 places

PEPITA (f, by Ekstern) **1 win** & 5 places

PERSEUSZ (c, by Laheeb) **1 win** & 3 places

PEGASUS (c, by Gazal Al Shaqab) **1 win** & 3 places.

POHULANKA (f, by Pepton) **1 win** & 7 places. Dam of:

POROST (c, by Metropolis NA) **3 wins** & 5 places.

PSYCHE (f, by Eukaliptus) **1 win** & 2 places. Dam of:

PAPAYA (f, by Ekstern) **1 win** & once 3rd placed

PESARO (c, by Arbil) **winner** in Poland.

No:12

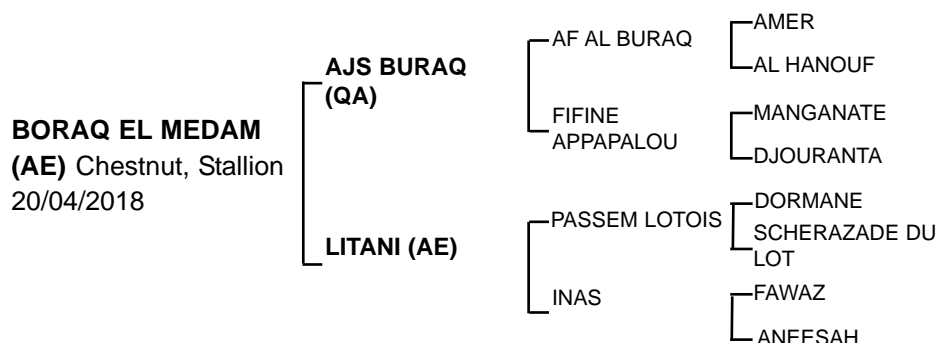

Sire: **AJS BURQA** (c, by AF Al Buraq) **1 win** & 6 places in Qatar & in UAE. His sire **AF AL BURQA** (c, by Amer) once 3rd place from 1 start. **FULL BROTHER** to **AF ALBAHAR**. sire of **Stakes winners** and performers. some of best progeny incl: **AF MAHER** (Dubai Kahayla Classic (Gr.1), **AF MAQAYES** (Al Ruwais (Gr.3), **AF AL HAZER** - Arabian Triple Crown R1, **AF AL SAJANJLE** - (Mazrat Al Ruwayah (Gr.2), **AF TAWAQ** - (2nd Al Maktoum Challenge R3 (Gr.1), **AF ALWAJEL** - (2nd Al Ruwais Stakes (Gr.3), **AF MAHSHOUM** - (Sheikh Zayed bin Sultan Al Nahyan National Day Cup (Gr.3), **AF AL ALMAA**, **AF AL JAHED**, **AF ASHRAS**, **AF HAKEEM**, **AF LA'ASAE**, , **AF SSAYEB**, **AF THOBAR**, **AF AL ASEF**, **AF AL SALLY**, **AF ASHEHAM**, **AF BAREQAH**, **AF KAFU**, **AF MADRUB**, , **AF MASHAREF**, **AF MONSEF**, **AF MUKHIFAH**, **AF TARAHA**, **AF TEBYAN**, **AF YATROOQ**, **AJS BURQA**, **AF AL MEHLEB**, **AF AL BAHER**, **AF AL BAIRAQ**, **AF AMJAD**, **AF AL MOREEB**, **AF GADEER**, **AF MAFATEN**, **AF MAKERAH**, **AF MEGHWAAR**, **AF MOMTAZ**, **AF MOTAGHATRES**, **AF MOUTHIRAH**, **AF WAQAS**, **AF MEZMAR**, **AF MEKHBAT**, **AF NAFECE**, **AF NOQOUSH**, **AF RAWIAH**, **AF SANAD**, **AF SHARESAH**, **AF THOBOR**, **AF TAREH AL THAHAB**, **AF TAGHZEL**, **AF YATROQ**, & many more.

1st Dam: **LITANI** (f, by Passem Lotois) 6 places in UAE. Her sire **PASSEM LOTOIS** (c, by Dormane) **4 wins** & 9 places from 13 starts. **1st Derby des Pur-Sang Arabes** (2,000 - Chantilly), 2nd Coupe d'Europe du Cheval Arabe (2,100 - Evry), 2nd Prix de La Barre (1,500 - Dax). Sire of **winner** incl: **RAIHAN**, **PASSEM LOTOIS** is **Half brother** to **SAMIR LOTOIS** (c, by Djenoun) **8 wins** & 11 places **DJEBEL LOTOIS** (c, by Zulus) **12 win** & 25 places.

2nd Dam: **INAS** (f, by Fawaz), Dam of:
MINNA (f, by Passem Lotois) **1 win** & 2 places.

No:13

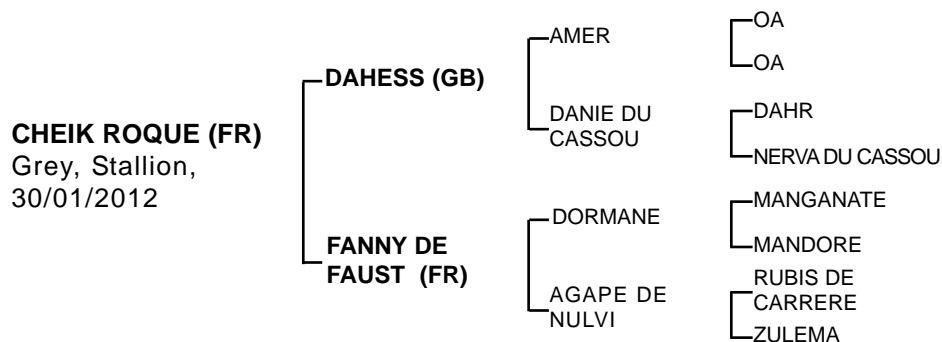

CHEIK ROQUE - 6 wins & 16 plaxces in UK & in UAE. 2nd Al Maktoum Challenge R1 (Gr.1), Mazrat Al Ruwayyah (Gr.2), 3rd Emirates Equestrian Federation International Stakes (Gr.2). Official Rating: 110

Sire:DAHESS (c, by Amer) 41 races, **28 wins**, 7 time Second, 3 time Third, with **13 Gr. wins** in 6 different Countries. about **One Million Euro of winnings** incl: **1st** The Al Hai Group Zaabeel International Stakes - (Gr.1)(X2), **1st** Al Bani Yas Al Hadheerah (Gr.2), **1st** P/A Sprinter Championship (Gr.3), **1st** Dubai Properties Zaabeel Int'l Stakes (Gr.1), **1st** H.H. The Emir's Sword (Gr.1), **1st** HH Sheikh Mohammed bin Khalifa Al Thani Trophy (Gr.1), **1st** The Malazgrit Trophy (Gr.1)(X2), **1st** The Grosseto International (Gr.1)(X2). Sire of many **winners** incl: **BRAMA DE POMPADOUR, DJAIKIRI SAFINAT, ZIKREET, CAKOUET DE BOZOULS, CHEIK ROQUE, FAWARAH, AINHOA DJASS, BADI, BAHESSE DES VIALETTES, BAHIA DU BARTHAS, BAKIR DE FLAUZINS, BAMBINO DU POUY, BEANIE DU CROATE, DORHESSE DE BRUGERE, MAHESSE DU SOLEIL, AJS RUDAINAH, VAHESSE DU CROATE, AL MOURTAJEZ, DAHOR DE BRUGERE, DJEBELIA AL MELS & many more.**

1st Dam: **FANNY DE FAUST** (f, by Dormane) **4 wins & 1 placed** in Morocco, Dam of:
FANIDI (c, by Leeroy De Chaillac) **12 wins & places** in Morocco.
YOUSR (c, by Youssar) **4 wins & 5 places** in Morocco.
BARDINE (c, by Leeroy De Chaillac) **1 win & 2 places** in Morocco.
DJEBEL DE LA ROQUE (c, by Dahess) **2 wins & 6 places** in Italy.

2nd Dam: **AGAPE DE NULVI** (f, by Rubis De Carrere) **1 win & 2 places** in Italy. **Full Sister** to **ZEFIRO DE NULVI & FATA DE NULVI**. Dam of:
AAWAJ AL KHALIDIAH (c, by Tiwaiq) **1 win & once 2nd placed, 1st Grand Prix** de S.A.R Le Prince Heritier Moulay El Hassan (Gr.3).

3rd Dam: **ZULEMA** (f, by Djourman) unraced, Dam of **winners** Incl:
FATA DE NULVI (f, by Rubis De Carrere) **10 wins & 16 places**
VISIR DE NULVI (c, by Rubis De Carrere) **6 wins & 8 places**
ELETTRA DE NULVI (f, by Rubis De Carrere) **2 wins & 2 places**
LAERTE DE NULVI (c, by Ulumu) **1 win & 4 places**
ZEFIRO DE NULVI (c, by Rubis De Carrere) **5 wins & was placed 31 times** in France, UK & U.A.E - **€116,524. 1st** President of the UAE Cup (Gr.1), 2nd Prix Baroud II (Gr.1), President of the UAE Cup (Gr.1), 3rd Coupe de Europe (Gr.1) President of the UAE Cup (Gr.1) - **Sire.**

No:14

AF ESHAAR (AE)
Chestnut, Stallion
06/01/2014

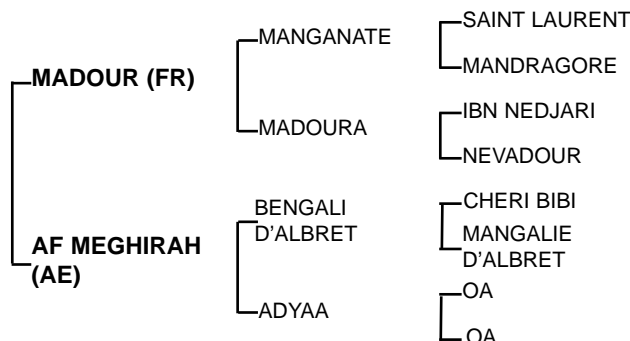

AF ESHAAR - 2 wins & 4 places. Official Rating: 45

Sire: MADOUR (c, by **Manganate**) **4 wins & 7 places** wining incl: **1st** Prix Frederic Bouas (1800 - Beaumont de Lomage), **1st** Zomorrodah Residential & Commercial Complex HCP (1400 - Jeb), **1st** Yas..... The Royal Name of Perfume HCP (2200 - Abu - Dhabi), **1st** alabbar HCP Glass & Aluminium (1600 - Jeb), 2nd Adnoc Distribution HCP (2200 - Abu Dhabi), 2nd Al Sada Magazine HCP (1800 - Jeb).

Sire of **winner**s incl:

BH ONE (out of Papita) **3 wins & 8 places**

AF QAMOOS (out of Voici Kossack) **2 wins & 13 places**

AF RAAD (out of Barriqe) **2 wins** in UAE

GABAS NOOR (out of Gabes) **4 wins & 4 places**

AS BAHE (out of Pamyła) **winner** in UAE

AF BELADI (out of Samba) **1 win & 3 places**

1st Dam: **AF MEGHIRAH** (f, by Bengali D'Albret) unraced. Dam of:

AF Daheea (f, by Amer) unplaced from 2 starts. Dam of:

AF MAHALEEL (2016 f, by Albar Lotois) **1 win & 2 places**.

Her sire **BENGALI D'ALBRET** (c, by **Cheri Bibi**), **16 wins & 8 places winning** incl: **1st** Prix Djerba Oua, **1st** Prix de la Barre, **1st** Prix du Grand Garage de Gascogne, **1st** Coupe d' Europe du Cheval Arabe(2), **1st** Dubai St.(2), **1st** The Al Ain International(2), **1st** Qatar Mesaoud St., **1st** Global Business Base Stakes, **1st** Harwood Stud Miss Lay Lyon St. 2nd Sheikh Maktoum Bin Rashid Al Maktoum Challenge Round I, 2nd National Day Cup, 3rd HH The President Cup.

In 2002 Bengali D'Albret was leading sire in GB by number of wins in front of Dormane & Djelfor (progency racing with ARO). Sire of many **winner**s incl:

A FOREIGN AFFAIR, AHDAAB, AJAYIB, AL DHEIBA, ARC KOSSACK, BARQ, BENNACHIE, BENEDIKT, BENGALIYA, BENGALANT, BANIKA, CS AL WAHED, CS COMET, ELKARIM, HIGHALNDER, JALJALAH, TORNADO & HATTEEN.

No:15

EXPO (AE)
Grey, Gelding,
04/03/2014

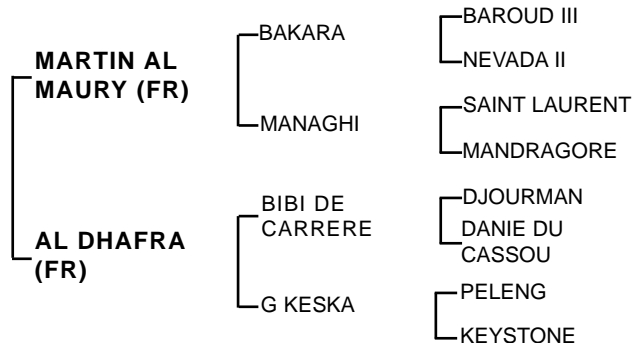

EXPO - once 5th placed, **OFFICIAL RATING: 35**

Sire: **MARTIN AL MAURY** (c, by Bakara) **2 wins** & places. 1st Green Line Hospitality Limited Condition (1600 - Abu Dhabi), 2nd Pindtada Pearls HCP, 5th Sh. Maktoum bin Rashid Al Maktoum Challenge Round II (**G1**), **Half Brother** to **TIDJANI** (c, by Flipper) **5 wins** from 5 starts. **BENJI** (c, by Cheri Bibi) **4 wins** & 4 places from 8 starts, **CHER-IFA** (f, by Cheri Bibi) **8 wins** & 3 places, **MERLIN AL MAURY** (c, by Baroud III) **5 wins** & 32 places. Sire of **many winners**.

1st Dam: **AL DHAFRA** (f, by **BIBI DE CARRERE** (c, by **Djourman**), **8 wins** & 3 places incl: **1st** Bayadeh Stakes, **1st** Al Hamrannah Stakes, **1st** Al-Madfa Race, **1st** Al Reef Stakes, 3rd Sheikh Maktoum Bin Rashid Al Maktoum Challenge Round I sire of many **winners** incl:

AHMADANI MUSAFER (out of Jureewan Monpelou) **7 wins** & 17 places

CARAT (out of Catania) **4 wins** & 8 places

DAYAN (out of Douja) **3 wins** & 2 places

RS KERIM (out of Kontrolnaia) **6 wins** & 3 places

SAKEN (out of DCA Rhapsody) **8 wins** & 7 places

DYNAMITE (out of No Answer) **9 wins** & 16 places. **History maker of**

Local Breed, First Local breed **winner** of **HH The President Cup** in UAE).

No:16

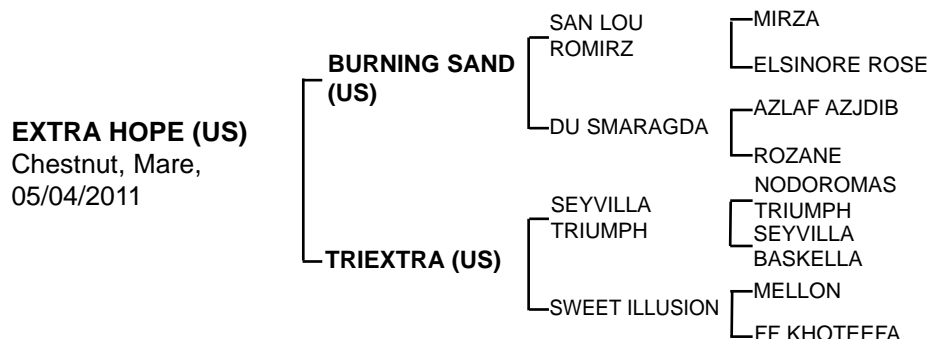
**EXTRA HOPE - 4 wins & 13 places**

Sire: **BURNING SAND** (c, by San Lou Romirz), **6 wins & 5 places incl: 2 Gr. wins & 1 Gr. place** from 11 starts - \$ 24,596 - Sire of **many winners** incl: **BIG EASY** (c, by Burning Sand) **23 wins & 15 places (incl: 6 Gr. wins & 9 Gr. places)** from 36 starts in USA & UAE - \$ 445,232. **LINE DANCER** - **24 wins & 5 places (incl: 17 Gr. wins & 4 Gr. places)** - \$ 423,061, **AIM SOUTH** - **16 wins & 37 places (incl: 7 Gr. wins & 10 Gr. places)** - \$ 383,468, **CATH** - **10 wins & 5 places (incl: 9 Gr. wins & 3 Gr. places)** - \$ 226,620, **ABRA CAADABRA** - **9 wins & 34 places (incl: 3 Gr. wins & 6 Gr. places)** - \$ 133,510, **QUICK SAND PW** - **7 wins & 13 places (incl: 3 Gr. wins & 5 Gr. places)** - \$ 117,049, **SAND WITCHEE** - **4 Gr. wins** including from **5 wins** from 5 starts - \$ 63,360, **REDA** - **4 wins & 8 places** (2017 Dubai Kahayla Classic (Gr.1)), **MAISOOR** - **9 wins & once 4th place** from 10 starts, **PADDY'S DAY** - **22 wins & 10 places**, **RB KINDLE**, **CODYS SURPRISE**, **HIGHH SHINE**, **UPTOWN SANDY GIRL**, **RB HOT DATE**, **SAND VICTOR**, **EXTRA HOPE**, **LADY DAWN AA**, **SANDICHEEKS**, **IVORY SHORES**, **RAINEING SAND** & many more.

1st Dam: **TRIEXTRA** (f, by Seyvilla Triumph) **3 wins & 3 places**, **1st California Filly Firecracker (Gr.3)**. Dam of:

EXTRA COOL (c, by Burning Sand) **3 wins & 4 places**

TRI ALAMO (g, by Ala Croixnoire) **1 win & 2 places**

TRI SPRING PROOF (f, by NF Proof) **2 wins & 10 places**, **2nd Dr Sam Harrison Juvenile Distaff S (Gr.2)**, Dam of:

AMYS LITTLE DIVA AA (f, by Burning Sand) **2 wins & 3 places**

BIG BEN (c, by Burning Sand) **3 wins & 16 places**

Angel Proof (f, by NF Proof) **4 places** in USA. Dam of:

ANGELINA AA (f, by Burning Sand) **1 win & 3 places**

EASTER MAN (c, by Burning Sand) **16 wins & 17 places**, **1st Delaware Park Arabian Classic H (Gr.1)**, **Hundred Years Sh.Zayed bin Sultan Al Nahyan S (Gr.1)**, **HH Sh. Zayed bin Sultan Al Nahyan Cup Amethyst Jewel S (Gr.1)**.

BURNING COMET (g, by Burning Sand) **2 wins & 13 places**

BURNING FLEET (c, by Burning Sand) **5 wins & 6 places**, **1st HH Sh. Zayed bin Sultan Al Nahyan Cup S (Gr.1)**, **Texas Six Shooter Arabian S (Gr.2)**, **Texas Arabian Derby (Gr.3)**.

2nd Dam: **SWEET ILLUSION** (f, by Mellon) unraced, Dam of:

TRI TRAVELLER (c, by Seyvilla Triumph) **2 wins & 6 places**.

TRI ILLUSIVE LADY (f, by Seyvilla Triumph) **1 win & 5 places** - **Broodmare**.

TRIUMPHS SILKIE (f, by Seyvilla Triumph) **7 wins & 6 places**.

No:17

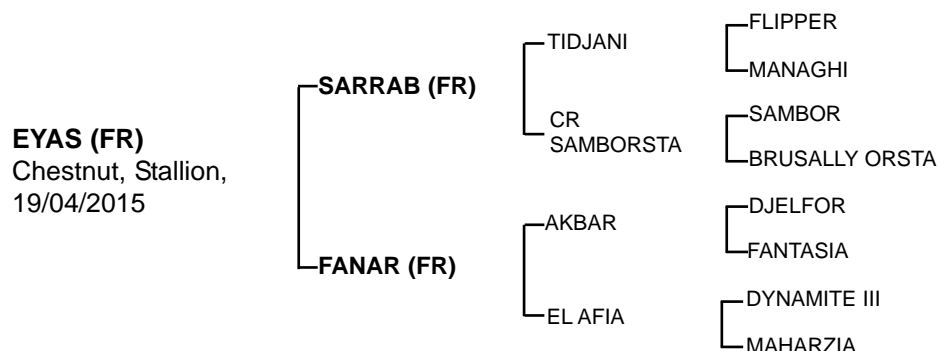

Sire: **SARRAB** (c, by Tidjani) **9 wins** & 12 places, incl; 4th Emirates Championship (Gr.1), 5th Emirates Championship (Gr.1). **Half Brother** to **ASSRAR, SABEAR, DARIYA & SAHLAMBO**. **Sire of winners incl: BADDI, YARAA, KANAAN, HAMMSA, DHAAFER** & many more.

1st Dam: **FANAR** (f, by Akbar) unraced, Dam of:

DAHAM (c, by Mahabb) **3 wins** & 5 places in France & in UAE, incl; **1st** Qatar Coupe de France des Chevaux Arabes (Gr.1), Prix Kesberoy (Gr.1), 3rd H.H. The President Cup (Gr.1).

MUNAAF (c, by Bibi De Carrere) **4 wins** & 11 places in UAE.

SHATEH (c, by Mahabb) **4 wins** & 10 places in France & in UAE, incl: **1st** Al Ruwais (Gr.3), 2nd Liwa Oasis (Gr.1), Bani Yas (Gr.2), Sh. Zayed bin Sultan Al Nahyan Cup (Gr.3).

2nd Dam: **EL AFIA** (f, by Dynamite III) **Full Sister** to **BERREZIG**, Dam of **winner** incl:

LAAMMA (c, by Munjiz) **2 wins** & 6 places in France & UAE, **1st** Arabian Triple Crown R2 in Abu Dhabi (Gr.3).

ABHAAR (c, by Tidjani) **1 win** & 3 places.

HIDERNE DE FAUST (f, by Tornado de Syrah) **2 wins** & 5 places in UK & UAE. 3rd The Hatta International Stakes (Gr.1)

JAWASS (c, by Dormane) **2 wins** & 6 places, 3rd Arabian Triple Crown II (Gr.3)

HABAIB (f, by Al Sakbe) **2 wins** & 5 places

Hafia de Faust (f, by Tidjani) unraced, Dam of:

HELLOW (c, by Kesberoy) **2 wins** & 7 places

HAMOUR (c, by Akbar) **3 wins** & 4 places

HAGNES DE FAUST (f, by Dormane) **2 wins** & 2 places in France & UAE, Dam of:

QIRFA DE FAUST (f, by Al Sakbe) **1 win** & 3 places in Morocco, 4th Grd Prix de SAR Le Prince Moulay Rachid (Gr.1)

SHAKIB DE FAUST (c, by Prince d'Orient) **1 win** & 3 places

VOLGA DE FAUST (f, by Munjiz) **2 wins** & 4 places.

3rd Dam: **MAHARZIA** (f, by Sibawain) 3 places from 3 starts, Dam of :

BERREZIG (c, by Dynamite III) **7 wins** & 15 places in Tunisia & Italy

HALFAOUINE (f, by Dynamite III) **2 wins** & 3 places. Dam of:

TURKAN TAJ (f, by Dormane) **2 wins** & 4 starts.

No:18

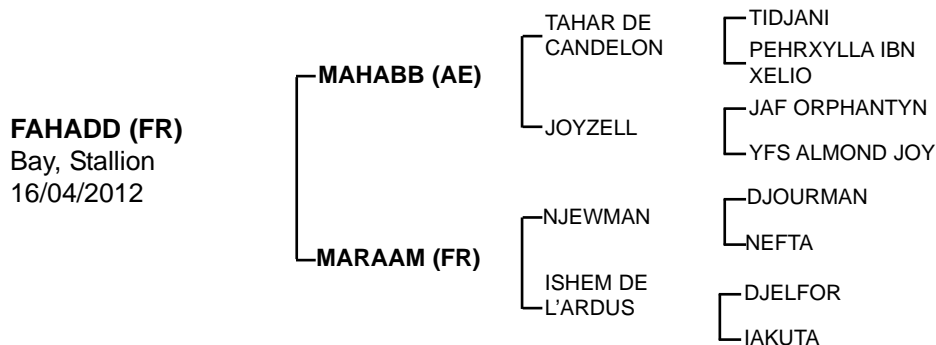
**FAHADD - 4 wins & 5 places. Official Rating: 40**

Sire: **MAHABB** (c, by Tahar de Candelon) 8 races, **5 wins & 3 places** at 4-5 in France & England - **\$41,071**, winning incl: **1st Prix Nefta (Gr.2)**, **1st Prix Damas (Gr.3)**, 2nd The Zaabeel International Stakes (**Gr.1**)(X2), 3rd French Arabian Breeder's Cup Mile (**Gr.1**) - **1200mtr record 1:16**, Sire of **many winners** incl: **MANARK, FAZAH, SARDAN, REKHA, MESTOR, AREEM SHATEH, AF HASBA, AF TATHOOR, TAYMOUR, JOORI, AF MO'ASSESS, ROCKMANE, SAUTERNES AL MAURY, MEYDAN DU PAON, THAKIF, CHALWA DU PAON, SHAHM, NASEEM, VISIONARY LADY & many more.**

1st Dam: **MARAAM** (f, by **NJEWMAN** (c, by Djourman) unraced, **Half Brother** to **NUITS ST GEORGE, NOMARCHIE, NOUILLAUGRATIN, NOBLE DAME, JAFFA DU BERLAIS, NJEWMAN**. Sire of **many winners** incl: **MUSHARAB** (Emirates Championship (**Gr.1**)), **VITELLA** (French Arabian Breeder's Cup Classic (**Gr.1**)), **SIMMBAD** (Prix Abu Dhabi (**Gr.1**)), **VERSAC PY** (Emirates Championship (**Gr.1**)), **SALAAMAH** (Emirates Equestrian Federation Int'l St (**Gr.2**)), **SPLEEN** (Prix Razzia III (**Gr.3**)), **MESSINE DE SINUHE, NO MAD, VIRE VOLTE, PILEPOILE, TIPPIE, LIZA, VIVA, SPIRALLE, SKOOP, SMALAH & many more).**

2nd Dam: **ISHEM DE L'ARDUS** (f, by Djelfor) **1 win & 5 places**, incl: 3rd Prix du Sultanat D'Oman. Dam of:

AAKIF (c, by Munjiz) **2 wins & 5 places**, incl: 2nd Sh.Zayed Bin Sultan Al Nahyan Prix Cheri Bibi (**Gr.2**).

RAKEEL (c, by Tidjani) **1 win & 11 places**

RAZIN (f, by Dormane) **1 win & 7 places**

TARFA (f, by Kerbella) **1 win & 2 places**

ATYAAB (f, by Tidjani) **1 win & 7 places.**

3rd Dam: **IAKUTA** (f, by Masan) placed in France, Dam of:

GHASAL DE L'ARDUS (g, by Kesberoy) **4 wins & 8 places**

Lamsa De L'Ardus (f, by Djelfor) once 3rd placed from 2 starts. Dam of:

DAKARE DE LARDUS (c, by Amperor des Cedres) **2 wins & 2 places**

Alfa De L'Ardus (f, by Kash De L'Ardus) unplaced, Dam of:

HOGGAR DE L'ARDUS (c, by Mister Ginoux) **2 wins** from 2 starts.

No:19

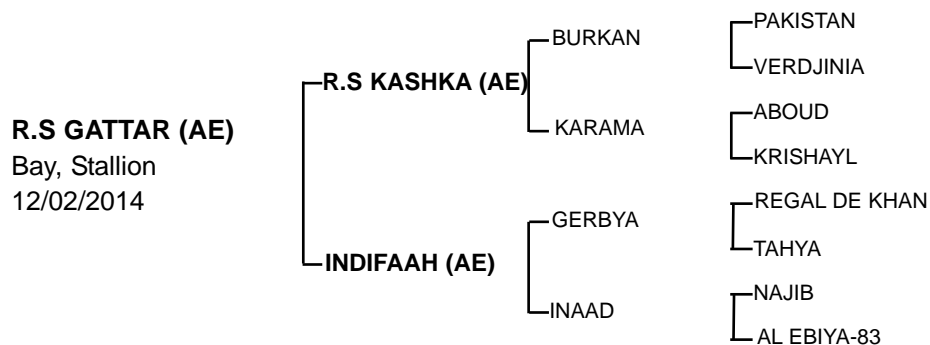

Sire: **R.S KASHKA** (c, by Burkan).

1st Dam: **INDIFAAH** (f, by **GERBYA** (c. by Regal de Khan) **3 wins**, 2nd (4 times) & placed 3 times in UAE. Rate 117 **winning** incl: **1st** Newmarket Race Course Trust HCP, **1st** H.H.Sh Khalifa Bin Zayed Al Nahyan Triple Crown Round III, **1st** H.H.Sh Khalifa Bin Zayed Al Nahyan Triple Crown Round I & 2nd Kahayla Classic, 2nd Adnoc Distribution HCP. Earned Prize more than **345,000 A.E.D** - Sire of many **winners**.

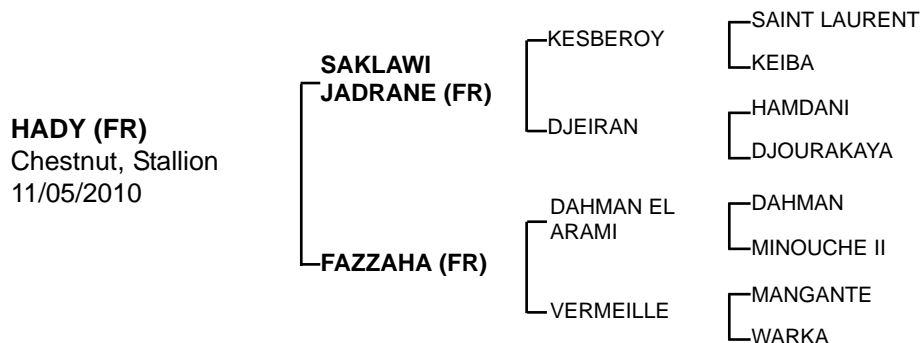
No:20

HADY - 1 win & placed from 2 starts, incl: 4th Coupe de France des Chevaux Arabes (Gr.1). **Official Rating: 99**

Sire: **SAKLAWI JADRANE** (c, Kesberoy), 8 wins and 4 places from 12 start, incl: **1st Prix du President des E.A.U.- Challenge Derby (G1)**, **Coupe d'Europe et des E.A.U. (Gr1)**, **La Coupe d'Al Asayl Management (Gr2)**, **La Coupe d'Al Asayl Management (Gr3)**, **Al Makatoum Challenge R2 (Gr1)**, **Al Makatoum Challenge R3(Gr1)**. and Sire of many winners incl: **AF MURSID - 2 wins** and placed 7 times at 4 and 5 years in U.A.E.; **KING - 1 win** at 4 years.; **MUJTAHID - 2wins** and placed once at 4 and 5 years, **MUDALLAL AL REEF - 3 wins** & 4 places, **EIZ AL REEF - 2 wins** & 6 places & many others.

1st Dam: **FAZZAHA** (f, by Dahman El Arami) Dam of:

DA'AREEN (f, by Bibi De Carrere) **5 wins** & 21 places

GHALIB (c, by Munjiz) **4 wins** & 15 places, **1st Prix Cheri Bibi (Gr.2)**, 2nd Prix Tidjani (Gr.3), 3rd Qatar Total Arabian Trophy (Gr.1).

NAJMAAH (f, by Sire D'Albret) **1 win** & 3 places. 5th Prix de L'Elevage (Gr.2).

QADER (c, by Munjiz) **5 wins** & 3 places

RASIKH (c, by Sire D'Albret) **5 wins** & 10 places, 2nd Coupe de France des Chevaux Arabes (Gr.1).

YARAA (f, by Sarrab) **3 wins** & 4 places, 2nd French Arabian Breeders Challenge (Gr.2).

2nd Dam: **VERMEILLE** (f, by Manganate) 4 places from 8 starts, Dam of:

FANDIM (g, by Bibi De Carrere) **2 wins** & 3 places

Fatenah (Regal De Khan) once 3rd place from 6 starts, Dam of:

BH FATAN (g, by Al Reef) **1 win** & 3 places in UAE.

Shaiyka (f, by Sire D'Albret) unplaced, Dam of:

NARJES (f, by Munjiz) **1 win** & 7 places, 5th Prix Razzia III (Gr.3).

3rd Dam: **WARKA** (f, by Navar) unraced. Dam of:

WAARH (f, by Djamel) **1 win** & 2 places

WAPITIE (f, by Manganate) **4 wins** & 7 places. Dam of:

WALL STREET (c, by Zacan El Baraka) **3 wins** & 14 places

VERT MOUSSE (f, by Djelfor) **2 wins** & 5 places

VERT GALANTE (f, by Dunixi) **5 wins** & 14 places. Dam of:

GHANTI (f, by Abitibi) **1 win** & once 2nd placed

VERDORA (c, by Dormane) **2 wins** & 7 places.

No:21

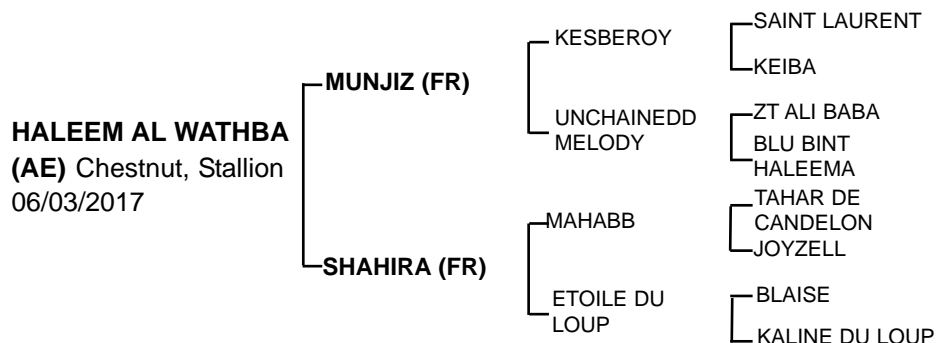

Sire: **MUNJIZ** (c, by Kesberoy) **1 win** & 4 places from 6 starts. **winner** of: Prix du President des Emirats Arabes Unis - Challenge Derby (**Gr.1**), 2nd Prix de Carthage (**Gr.2**), 3rd Prix du Haras de Gelos. **Half brother** to **MIZZNA**, **MIJDADD**. Sire of **winners** incl: **JOSCO DU CAUROU**, **GHALIB**, **SAHLAMBO**, **MUNZADE**, **MYRA DE MONLAU**, **AAKIF**, **AL MAMUN MONLAU**, **AWAM**, **ELYAAH**, **AL BASHTOON**, **MISTER DU LOUP**, **MELK**, **FANTASY MISS**, **LADY WISH**, **MISS FANTASIA**, **MASCATE**, **GHADEER**, **KARLOS DU CAYROU**, **ZAKHO**, **THABIT**, **BANDAR**, **NAJAH**, **YATHRIB**, **MUNOWRA**, **AUSTRALYA**, **SOMOUD**, **ESKANDAR**, **BASEEL**, **DUZAR**, **MUNZADE**, **CANDAHAR**, **MUSHARAF** & many more.

1st Dam: **SHAHIRA** (f, by Mahabb) unplaced from 4 starts. Dam of:
SHADDAD AL WATHBA (c, by Bibi De Carrere) **1 win** from 3 starts.

2nd Dam: **ETOILE DU LOUP** (f, by Blaise) unraced, Dam of:

LAHIB (c, by Kairouan de Jos) **5 wins** & 7 places

ESKANDAR (c, by Munjiz) **1 win** & 1 place

MUBASHER (c, by Bibi de Carrere) **1 win** & 5 places

WAASEL (c, by Kerbella) **1 win** & 6 places

HARB (g, by Kerbella) **1 win** & 5 places

Aleefa (f, by Kesberoy) 6 places from 6 starts. Dam of:

NAZIQ (f, by Mahabb) **2 wins** & 3 places

LORAA (f, by Mawood) **6 wins** & 7 places

FAZAH (f, by Mahabb) **3 wins** & 3 places.

Eshraq (f, by Djelfor) unraced, Dam of:

DIG DAGON (c, by Bibi De Carrere) **3 wins** & 17 places.

WADYA (f, by Akbar) **5 wins** & 7 places in France & in UAE. incl: 5th Emirates Championship (**Gr.1**). Dam of:

SOMOUD (c, by Munjiz) **5 wins** & 11 places in France & in UAE. incl: Emirates Championship (**Gr.1**), Al Ain Mile (**Gr.3**).

3rd Dam: **KALINE DU LOUP** (f, by Djouras Tu) 4 places from 5 starts. Dam of:

CALIN DE LOUVE (c, by Djelfor) **8 wins** from 8 starts. incl: Darley Stud Arabian Cup Classic (**Gr.1**), AJC Derby (**Gr.1**), Drinkers of the Wind Futurity (**Gr.2**), California Futurity (**Gr.3**). Earned Prize money more than **\$123,000 USD - Sire**.

KAL BARQ (c, by Dormane) **9 wins** & 10 places in UAE.

KHATTAFF (c, by Dormane) **1 win** & 5 places.

RAHEQ (g, by Kerbella) **1 win** & 13 places.

No:22

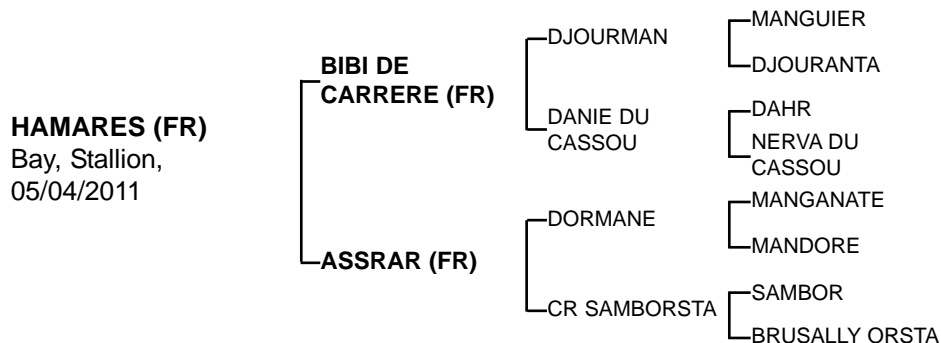
**HAMARES - 2 wins & 11 places. Official Rating: 65 Turf/ 78 Dirt**

Sire:**BIBI DE CARRERE** (c, by Djourman) **8 wins** and 6 places from 17 starts at 3- 5yo in France & UAE, Sire of **many winners** incl: **RABBAH DE CARRERE - 5 wins & 5 places**, **DYNAMITE - 10 wins & 23 places** - The First Local bred in the History of Arabian Racing to winner of HH The President Cup (Gr.1), **NAHEE - 4 wins & 4 places**, **CARAT - 4 wins & 8 places**, **SHA'RED - 2 wins & 5 places**, **MARZOOQ - 2 wins & 1 place**, **RS KERIM - 6 wins & 3 places**, **SAKEN - 8 wins & 6 places** & among others.

1st Dam: **ASSRAR** (f, by Dormane) **2 wins & 1 place** from 3 starts. Dam of:
BASEEL (f, by Munjiz) **3 wins & 1 place** from 4 starts in France. incl: Prix Nevada II (Gr.3), Prix Razzia III (Gr.3), 3rd Qatar Arabian Trophy des Pouliches (Gr.1).
ASLAAN (c, by Bibi De Carrere) **4 wins & 10 places**
HAMARES (c, by Bibi De Carrere) **Subject Horse**.

2nd Dam: **CR SAMBORSTA** (f, by Sambor) **7 wins & 3 places** from 11 starts, Incl:
1st AJC Debutante Handicap, AJC Delaware Stakes, Delaware Arabian Cup Juvenile Fillies, Fire Cracker Futurity VI, Korona Arabian Cup Juvenile Fillies, 2nd AJC California Stakes, Dam of **winners** incl:
SABEAR (f, by Dormane) **5 wins & 14 places**
SARRAB (c, by Tidjani) **9 wins & 12 places**
DARIYA (c, by Dormane) **8 wins & 8 places**
SAHER (g, by Tornado de Syrah) **2 wins & 7 places**
SAHLAMBO (f, by Munjiz) **7 wins & 6 places**
SYRIANAH (f, by Dormane) **3 wins & 8 places**
SAMJIDA (f, by Majd Al Arab) **2 wins & 5 places**
HERCEY SEINE (c, by Majd Al Arab) **1 win & 1 place** from 3 starts.
MANNAR (f, by Djelfor) unraced. Dam of:
MARAM (c, by Nez d'Or) **3 wins & 8 places**
Shahranaz (f, by Scharly) unraced, Dam of:
MUSHAIRIB (c, by Calin du Loup) **1 win & 5 places** from 7 starts.

No:23

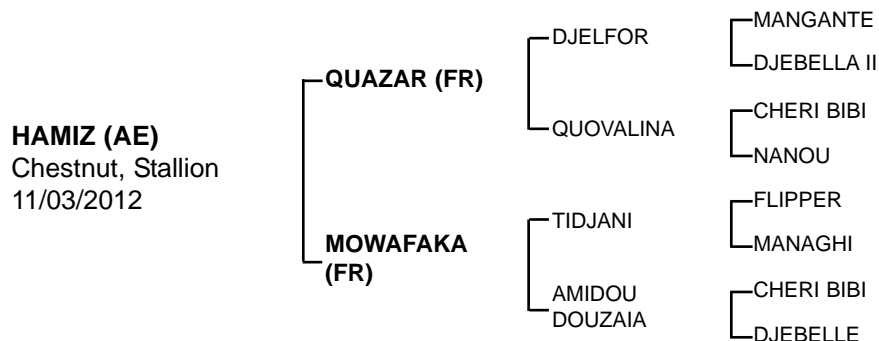

Sire: **QUAZAR** (c. by Djelfor) **3 wins** & 1 place from 4 starts, incl: Abu Dhabi Int'l Championship (**Gr.1**) & Prix d'Abu Dhabi (**Gr.1**). Sire of **HAANOOF** - **4 wins** & 12 places. **SAARAH** - 1 win & 6 places, **Half Brother** to **VERMILLON** - **10 wins**, **VENT DREDY** - **5wins**. **VERDOYANTE** - **2 wins**, **VERT TIGE** - **2 wins**, **VERLINO** - **10 wins**.

1st Dam: **MOWAFKA** (f, by Tidjani) unraced, Dam of:

ELAF (f, by Rabbah De Carrere) **1 win** & 4th Qatar Arabian Trophy (**Gr.1**).

BAYAN (f, by Munjiz) **3 wins** & 4 places. **1st Hatta International Stakes (Gr.1)**, Qatar Prix de L'Elevage (**Gr.2**), 2nd Qatar Arabian Trophy (**Gr.1**), Prix Razzia III (**Gr.3**).

2nd Dam: **AMIDOU DOUZAIA** (f, by Cheri Bibi) **6 wins** & 5 places. Dam of:

MESSINE DE SINUHE (c, by Njewman) **4 wins** & 10 places

LILLY ROCK (f, by Akbar) **1 win** & 2 places from 3 starts

SALAAMAH (f, by Njewman) **3 wins** & 4 places

DAHWA (f, by Tidjani) **2 wins** & 10 places. Dam of:

THABIT (c, by Munjiz) **4 wins** & 8 places

BANDAR (c, by Munjiz) **3 wins** & 7 places

NAJAH (f, by Munjiz) **2 wins** & 2 places

HABOOB (f, by Akbar) **1 win** & 2 places. Dam of:

SHAHM (c, by Mahabb) **3 wins** & 2 places

MARZOOQ (c, by Bibi De Carrere) **2 wins** & 2 places

YATHRIB (f, by Munjiz) **1 win** & 5 places

AMJAD (f, by Akbar) **1 win** & 3 places

ARYAAN (f, by Kesberoy) **1 win** & 4 places. Dam of:

LAHAHQ (c, by Dormane) **3 wins** & 2 places

NASEEM (c, by Mahabb) **6 wins** & 8 places

ALIAA (f, by Djelfor) **3 wins** & 2 places in UAE. Dam of:

ABHAAR (c, by Al Nasr) **7 wins** & 5 places

FATAT AL ARAB (f, by Al Nasr) **3 wins** & 2 places

ASYAD (f, by TH Richie) **1 win** & 9 places.

MUSTAJEEB (g, by Calin Du Loup) **1 win** & 2 places.

ASSILA (f, by Dormane) **1 win** & 3 places from 5 starts in UAE. Dam of:

AASAL AL REEF (f, by Bibi De Carrere) **1 win** & 9 places.

3rd Dam: **DJEBELLE** (f, by Ourour) unraced, Dam of:

QUELERMAN (g, by Cheri Bibi) **2 wins** & 6 places

TESSADITE (f, by Tidjani) **1 win** & 6 places

UMOUR (c, by Horr) **1 win** & 7 places

No:24

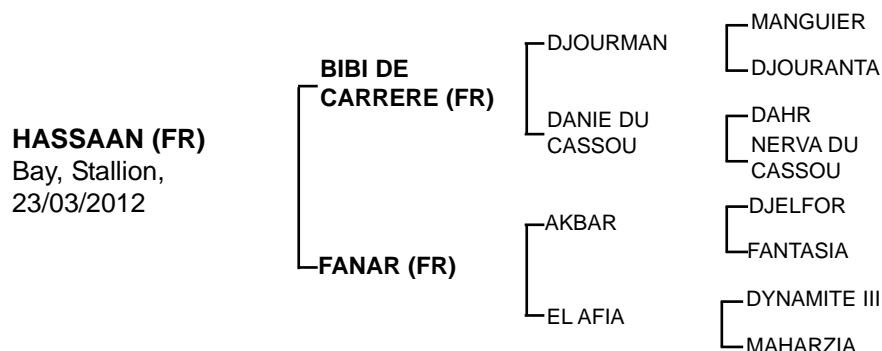

Sire:**BIBI DE CARRERE** (c, by Djourman) **8 wins** and 6 places from 17 starts at 3- 5yo in France & UAE, Sire of **many winners** incl: **RABBAH DE CARRERE - 5 wins & 5 places**, **DYNAMITE - 10 wins & 23 places** - The First Local bred in the History of Arabian Racing to winner of HH The President Cup (**Gr.1**), **NAHEE - 4 wins & 4 places**, **CARAT - 4 wins & 8 places**, **SHA'RED - 2 wins & 5 places**, **MARZOOQ - 2 wins & 1 place**, **RS KERIM - 6 wins & 3 places**, **SAKEN - 8 wins & 6 places** & among others.

1st Dam: **FANAR** (f, by Akbar) unraced, Dam of:

DAHAM (c, by Mahabb) **3 wins & 5 places** in France & in UAE, incl; **1st** Qatar Coupe de France des Chevaux Arabes (**Gr.1**), Prix Kesberoy (**Gr.1**), 3rd H.H. The President Cup (**Gr.1**).

MUNAAF (c, by Bibi De Carrere) **4 wins & 11 places** in UAE.

SHATEH (c, by Mahabb) **4 wins & 10 places** in France & in UAE, incl: **1st** Al Ruwais (**Gr.3**), 2nd Liwa Oasis (**Gr.1**), Bani Yas (**Gr.2**), Sh. Zayed bin Sultan Al Nahyan Cup (**Gr.3**).

2nd Dam: **EL AFIA** (f, by Dynamite III) **Full Sister** to **BERREZIG**, Dam of **winner** incl:

LAAMMA (c, by Munjiz) **2 wins & 6 places** in France & UAE, **1st** Arabian Triple Crown R2 in Abu Dhabi (**Gr.3**).

ABHAAR (c, by Tidjani) **1 win & 3 places**.

HIDERNE DE FAUST (f, by Tornado de Syrah) **2 wins & 5 places** in UK & UAE. 3rd The Hatta International Stakes (**Gr.1**)

JAWASS (c, by Dormane) **2 wins & 6 places**, 3rd Arabian Triple Crown II (**Gr.3**)

HABAIB (f, by Al Sakbe) **2 wins & 5 places**

Hafia de Faust (f, by Tidjani) unraced, Dam of:

HELLOW (c, by Kesberoy) **2 wins & 7 places**

HAMOUR (c, by Akbar) **3 wins & 4 places**

HAGNES DE FAUST (f, by Dormane) **2 wins & 2 places** in France & UAE, Dam of:

QIRFA DE FAUST (f, by Al Sakbe) **1 win & 3 places** in Morocco, 4th Grd Prix de SAR Le Prince Moulay Rachid (**Gr.1**)

SHAKIB DE FAUST (c, by Prince d'Orient) **1 win & 3 places**

VOLGA DE FAUST (f, by Munjiz) **2 wins & 4 places**.

3rd Dam: **MAHARZIA** (f, by Sibawain) 3 places from 3 starts, Dam of :

BERREZIG (c, by Dynamite III) **7 wins & 15 places** in Tunisia & Italy

HALFAOUINE (f, by Dynamite III) **2 wins & 3 places**. Dam of:

TURKAN TAJ (f, by Dormane) **2 wins & 4 starts**.

No:25

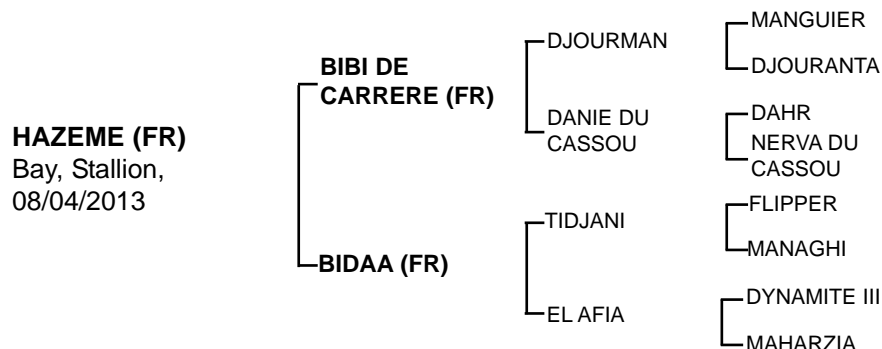

HAZEME - 1 win & 12 places, Official Rating: 50.

Sire:**BIBI DE CARRERE** (c, by Djourman) **8 wins** and 6 places from 17 starts at 3- 5yo in France & UAE, Sire of **many winners** incl: **RABBAH DE CARRERE - 5 wins & 5 places**, **DYNAMITE - 10 wins & 23 places** - The First Local bred in the History of Arabian Racing to winner of HH The President Cup (**Gr.1**), **NAHEE - 4 wins & 4 places**, **CARAT - 4 wins & 8 places**, **SHA'RED - 2 wins & 5 places**, **MARZOOQ - 2 wins & 1 place**, **RS KERIM - 6 wins & 3 places**, **SAKEN - 8 wins & 6 places** & among others.

1st Dam: **BIDAA** (f, by Tidjani) unraced, Dam of:
DOHAA (f, by Munjiz) **1 win** & once placed.

2nd Dam: **EL AFIA** (f, by Dynamite III) **Full Sister** to **BERREZIG**, Dam of **winner** incl:
LAAMMA (c, by Munjiz) **2 wins & 6 places** in France & UAE, **1st Arabian Triple Crown R2** in Abu Dhabi (**Gr.3**).

ABHAAR (c, by Tidjani) **1 win & 3 places**.

HIDERNE DE FAUST (f, by Tornado de Syrah) **2 wins & 5 places** in UK & UAE.

JAWASS (c, by Dormane) **2 wins & 6 places**, 3rd Arabian Triple Crown II (**Gr.3**)

HABAIB (f, by Al Sakbe) **2 wins & 5 places**

Hafia de Faust (f, by Tidjani) unraced, Dam of:

HELLOW (c, by Kesberoy) **2 wins & 7 places**

HAMOUR (c, by Akbar) **3 wins & 4 places**

HAGNES DE FAUST (f, by Dormane) **2 wins & 2 places** in France & UAE, Dam of:

QIRFA DE FAUST (f, by Al Sakbe) **1 win & 3 places** in Morocco,

SHAKIB DE FAUST (c, by Prince d'Orient) **1 win & 3 places**

VOLGA DE FAUST (f, by Munjiz) **2 wins & 4 places**.

Fanar (f, by Akbar) unraced, Dam of:

DAHAM (c, by Mahabb) **3 wins & 5 places** in France & in UAE, incl; **1st Qatar Coupe de France des Chevaux Arabes (Gr.1)**, Prix Kesberoy (**Gr.1**),

MUNAAF (c, by Bibi De Carrere) **4 wins & 11 places** in UAE.

SHATEH (c, by Mahabb) **4 wins & 10 places** in France & in UAE, incl: **1st Al Ruwais (Gr.3)**, 2nd Liwa Oasis (**Gr.1**), Bani Yas (**Gr.2**), Sh. Zayed bin Sultan Al Nahyan Cup (**Gr.3**).

3rd Dam: **MAHARZIA** (f, by Sibawain) 3 places from 3 starts, Dam of :

BERREZIG (c, by Dynamite III) **7 wins & 15 places** in Tunisia & Italy

HALFAOUINE (f, by Dynamite III) **2 wins & 3 places**. Dam of:

TURKAN TAJ (f, by Dormane) **2 wins & 4 starts**.

No:26

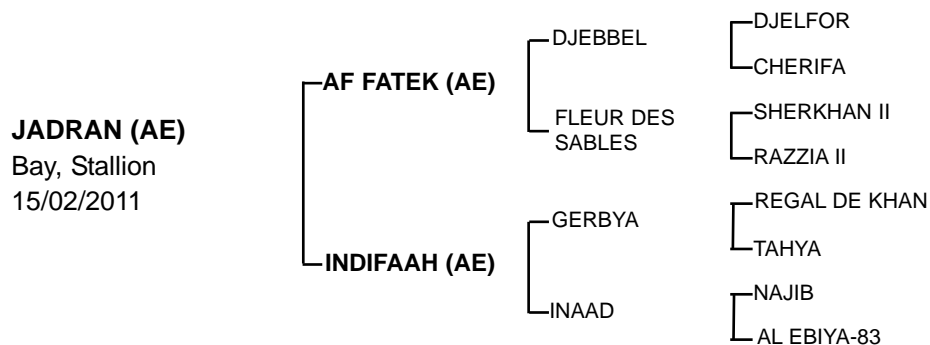

Sire: **AF FATEK** (c, by Djebbel) 2 times 2nd placed from 6 starts. **Half Brother** to **OPHELYA** (f, by Tidjani) **2 wins** & 8 places. His sire **DJEBBEL (c, by Djelfor)** **11 wins & 8 places**. Sire of many winners incl: **AL MOUTTAKEL, IZZ, KHATTAF, HAJAJ, DIRGAM, SANTHAL, SADJELLA & among others**.

1st Dam: **INDIFAAH** (f, by **GERBYA** (c. by Regal de Khan) **3 wins**, 2nd (4 times) & placed 3 times in UAE. Rate 117 **winning** incl: **1st** Newmarket Race Course Trust HCP, **1st** H.H.Sh Khalifa Bin Zayed Al Nahyan Triple Crown Round III, **1st** H.H.Sh Khalifa Bin Zayed Al Nahyan Triple Crown Round I & 2nd Kahayla Classic, 2nd Adnoc Distribution HCP. Earned Prize more than **345,000 A.E.D** - Sire of many **winners**.

No:27

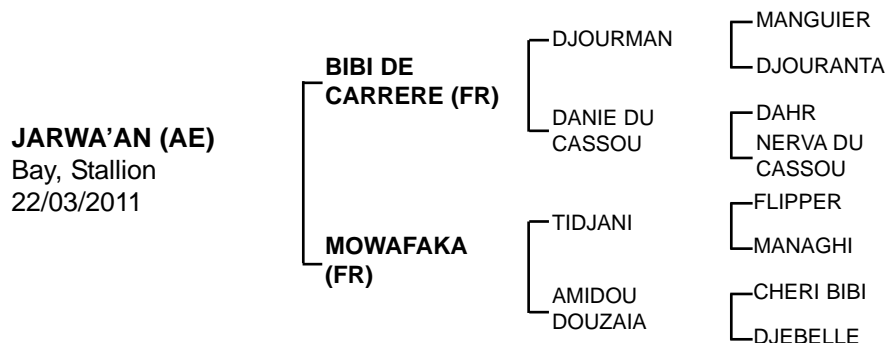

Sire: **BIBI DE CARRERE** (c, by Djourman) **8 wins** and 6 places from 17 starts at 3- 5yo in France & UAE, Sire of **many winners** incl: **RABBAH DE CARRERE - 5 wins** & 5 places, **DYNAMITE - 10 wins** & 23 places - The First Local bred in the History of Arabian Racing to winner of HH The President Cup (**Gr.1**), **NAHEE - 4 wins** & 4 places, **CARAT - 4 wins** & 8 places, **SHA'RED - 2 wins** & 5 places, **MARZOOQ - 2 wins** & 1 place, **RS KERIM - 6 wins** & 3 places, **SAKEN - 8 wins** & 6 places & among others.

1st Dam: **MOWAFAKA** (f, by Tidjani) unraced, Dam of:

ELAF (f, by Rabbah De Carrere) **1 win** & 4th Qatar Arabian Trophy (**Gr.1**).

BAYAN (f, by Munjiz) **3 wins** & 4 places. **1st** Hatta International Stakes (**Gr.1**), Qatar Prix de L'Elevage (**Gr.2**), 2nd Qatar Arabian Trophy (**Gr.1**), Prix Razzia III (**Gr.3**).

2nd Dam: **AMIDOU DOUZAIA** (f, by Cheri Bibi) **6 wins** & 5 places. Dam of:

MESSINE DE SINUHE (c, by Njewman) **4 wins** & 10 places

LILLY ROCK (f, by Akbar) **1 win** & 2 places from 3 starts

SALAAMAH (f, by Njewman) **3 wins** & 4 places

DAHWA (f, by Tidjani) **2 wins** & 10 places. Dam of:

THABIT (c, by Munjiz) **4 wins** & 8 places

BANDAR (c, by Munjiz) **3 wins** & 7 places

NAJAH (f, by Munjiz) **2 wins** & 2 places

HABOOB (f, by Akbar) **1 win** & 2 places. Dam of:

SHAHM (c, by Mahabb) **3 wins** & 2 places

MARZOOQ (c, by Bibi De Carrere) **2 wins** & 2 places

YATHRIB (f, by Munjiz) **1 win** & 5 places

AMJAD (f, by Akbar) **1 win** & 3 places

ARYAAN (f, by Kesberoy) **1 win** & 4 places. Dam of:

LAAHAQ (c, by Dormane) **3 wins** & 2 places

NASEEM (c, by Mahabb) **6 wins** & 8 places

ALIAA (f, by Djelfor) **3 wins** & 2 places in UAE. Dam of:

ABHAAR (c, by Al Nasr) **7 wins** & 5 places

FATAT AL ARAB (f, by Al Nasr) **3 wins** & 2 places

ASYAD (f, by TH Richie) **1 win** & 9 places.

MUSTAJEEB (g, by Calin Du Loup) **1 win** & 2 places.

ASSILA (f, by Dormane) **1 win** & 3 places from 5 starts in UAE. Dam of:

AASAL AL REEF (f, by Bibi De Carrere) **1 win** & 9 places.

3rd Dam: **DJEBELLE** (f, by Ourour) unraced, Dam of:

QUELERMAN (g, by Cheri Bibi) **2 wins** & 6 places.

No:28

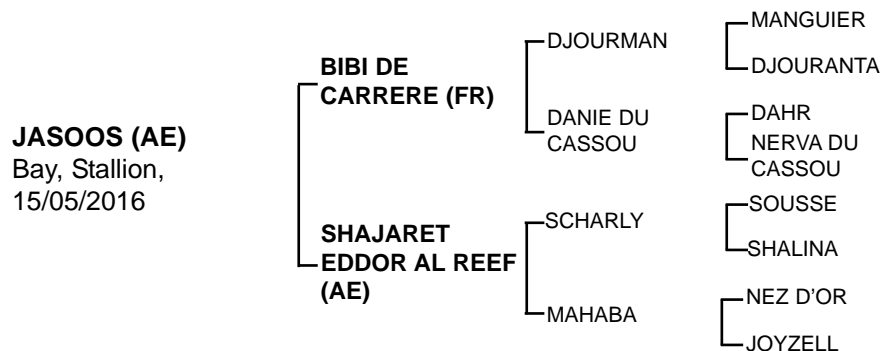

Sire: **BIBI DE CARRERE** (c, by Djourman) **8 wins** and 6 places from 17 starts at 3- 5yo in France & UAE, Sire of **many winners** incl: **RABBAH DE CARRERE - 5 wins & 5 places**, **DYNAMITE - 10 wins & 23 places** - The First Local bred in the History of Arabian Racing to winner of HH The President Cup (**Gr.1**), **NAHEE - 4 wins & 4 places**, **CARAT - 4 wins & 8 places**, **SHA'RED - 2 wins & 5 places**, **MARZOOQ - 2 wins & 1 place**, **RS KERIM - 6 wins & 3 places**, **SAKEN - 8 wins & 6 places** & among others.

1st Dam: **SHAJARET EDDOR AL REEF** (f, by Scharly) **1 win & 18 places**, Dam of:
SALAF (c, by Munjiz) **1 win & once 2nd placed**.
MUSHEER AL WATHBA (c, by Tahar De Candelon) **2 wins & 2 places**
SHAWALL (g, by Bibi De Carrere) **1 win & 13 places**
Shamaah Al Wathba (2016 f, by Mijadd) 4th placed from 2 starts.

2nd Dam: **MAHABA** (f, by Nez D'or) unraced, Dam of:
EL GHOUL (c, by Saklawi Jadrane) **winner** in UAE.
KARDOOS (c, by Saklawi Jadrane) **1 win & 7 places**, 3rd French Arabian Breeders Challenge (**Gr.3**)
MULHIM (c, by Bibi De Carrere) **1 win & 4 places**.

3rd Dam: **JOYZELL (MAHA)** (f, by Jaf Orphatyn) **Sprint Champion, Highest Race record** in USA & UAE. **29 wins** from 29 races since 3yo to 10yo. **Champion** in UAE **25 wins** for 25 races, **Top Rating - 140. World Record** 1000m record - Abu Dhabi: **1.02:06** & 1200m record - Abu Dhabi: **1.16:67**. .Dam of:
LAHAB (c, by Tahar de Candelon) **3 wins & 6 places** in UAE,
MAHABB (c, by Tahar de Candelon) 8 races, **5 wins & 3 places** at 4-5 in France & England - **\$41,071**, winning incl: **1st Prix Nefta (Gr.2)**, **1st Prix Damas (Gr.3)**, 2nd The Zaabeel International Stakes (**Gr.1**)(**X2**), 3rd French Arabian Breeder's Cup Mile (**Gr.1**) - **1200mtr record 1:16**, Sire of **many winners** incl: **MANARK, FAZAH, SARDAN, REKHA, MESTOR, AREEM SHATEH, AF HASBA, AF TATHOOR, TAYMOUR, JOORI, MEYDAN DU PAON, AF MO'ASSESS, ROCKMANE, SAUTERNES AL MAURY, THAKIF, CHALWA DU PAON, SHAHM, NASEEM, VISIONARY LADY** & many more.

No:29

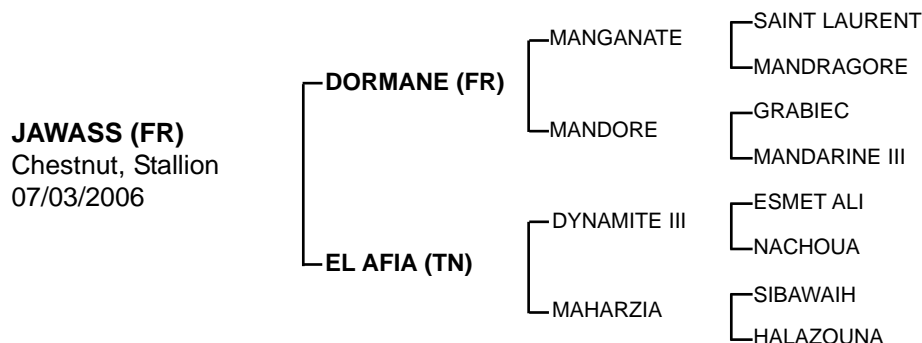

JAWASS - 2 wins & 2 places, 3rd Arabian Triple Crown R2 (Gr.3).

Sire: **DORMANE** (c, by Manganate), Bred in France. He raced as a 3 and 4 year old and had **six wins**. He is own brother to **Djamel, Madjel, Djenbel**, and **Margau** Dam of **Massamarie**. **Dormane** is the **Championship sire** of his **generation** and is sire of **winners** including, **Dorwan Du Cayrou, Passem Lotois, Darike, Chndaka, Chaikh Man, Noreen, Nisae**.

1st Dam: **EL AFIA** (f, by Dynamite III) **Full Sister** to **BERREZIG**, Dam of **winner** incl: **LAAMMA** (c, by Munjiz) **2 wins & 6 places** in France & UAE, **1st Arabian Triple Crown R2** in Abu Dhabi (**Gr.3**).

ABHAAR (c, by Tidjani) **1 win & 3 places**.

HIDERNE DE FAUST (f, by Tornado de Syrah) **2 wins & 5 places** in UK & UAE. 3rd The Hatta International Stakes (**Gr.1**)

JAWASS (c, by Dormane) **2 wins & 6 places**, 3rd Arabian Triple Crown II (**Gr.3**)

HABAIB (f, by Al Sakbe) **2 wins & 5 places**

Hafia de Faust (f, by Tidjani) unraced, Dam of:

HELLOW (c, by Kesberoy) **2 wins & 7 places**

HAMOUR (c, by Akbar) **3 wins & 4 places**

HAGNES DE FAUST (f, by Dormane) **2 wins & 2 places** in France & UAE, Dam of: **QIRFA DE FAUST** (f, by Al Sakbe) **1 win & 3 places** in Morocco, 4th Grd Prix de SAR Le Prince Moulay Rachid (**Gr.1**)

SHAKIB DE FAUST (c, by Prince d'Orient) **1 win & 3 places**

VOLGA DE FAUST (f, by Munjiz) **2 wins & 4 places**.

Fanar (f, by Akbar) unraced, Dam of:

DAHAM (c, by Mahabb) **3 wins & 5 places** in France & in UAE, **1st Qatar Coupe de France des Chevaux Arabes (Gr.1)**, Prix Kesberoy (**Gr.1**).

MUNAAF (c, by Bibi De Carrere) **4 wins & 11 places** in UAE.

SHATEH (c, by Mahabb) **4 wins & 10 places** in France & in UAE, incl: **1st Al Ruwais (Gr.3)**, 2nd Liwa Oasis (**Gr.1**), Bani Yas (**Gr.2**), Sh. Zayed bin Sultan Al Nahyan Cup (**Gr.3**).

Bidaa (f, by Tidjani) unraced, Dam of:

DOHAA (f, by Munjiz) **1 win & once placed**.

HAZEME (c, by Bibi De Carrere) **1 win & 12 places**.

2nd Dam: **MAHARZIA** (f, by Sibawain) 3 places from 3 starts, Dam of :

BERREZIG (c, by Dynamite III) **7 wins & 15 places** in Tunisia & Italy

HALFAOUINE (f, by Dynamite III) **2 wins & 3 places**. Dam of:

TURKAN TAJ (f, by Dormane) **2 wins & 4 starts**.

No:30

KARAMA (AE)
Grey, Mare,
14/01/1995

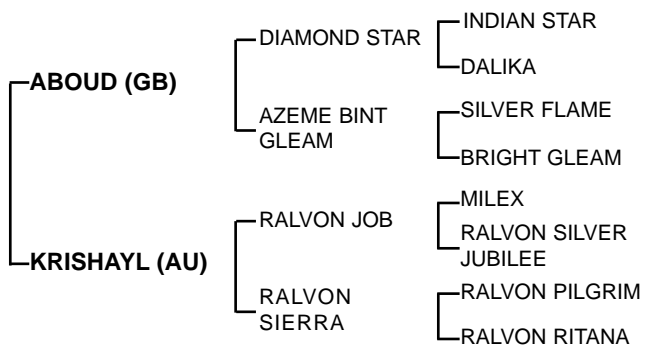

Sire: **ABOUD** (c, by Diamond Star)

1st Dam: **KRISHAYL** (f, by Ralvon Job)

No:31

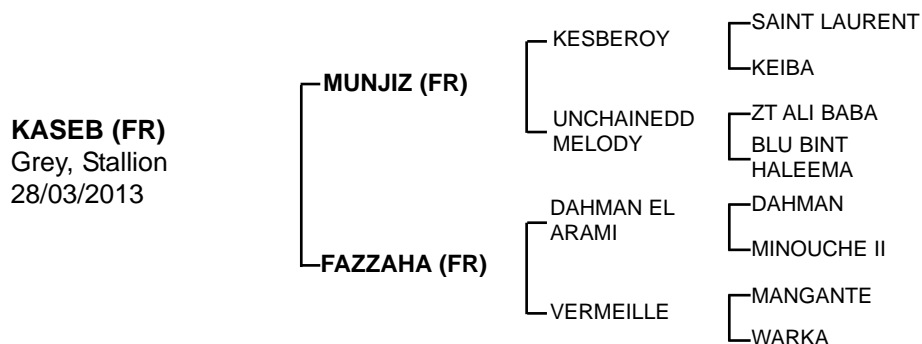

KASEB - 3 placed from 4 starts, **Official Rating: 50**

Sire: **MUNJIZ** (c, by Kesberoy) **1 win** & 4 places from 6 starts. **winner** of: Prix du President des Emirats Arabes Unis - Challenge Derby (**Gr.1**), 2nd Prix de Carthage (**Gr.2**), 3rd Prix du Haras de Gelos. **Half brother** to **MIZZNA**, **MIJDADD**. Sire of **winners** incl: **JOSCO DU CAUROU**, **GHALIB**, **SAHLAMBO**, **MUNZADE**, **MYRA DE MONLAU**, **AAKIF**, **AL MAMUN MONLAU**, **AWAM**, **ELYAAH**, **AL BASHTOON**, **MISTER DU LOUP**, **MELK**, **FANTASY MISS**, **LADY WISH**, **MISS FANTASIA**, **MASCATE**, **GHADEER**, **KARLOS DU CAYROU**, **ZAKHO**, **THABIT**, **BANDAR**, **NAJAH**, **YATHRIB**, **MUNOWRA**, **AUSTRALYA**, **SOMOUD**, **ESKANDAR**, **BASEEL**, **DUZAR**, **MUNZADE**, **CANDAHAR**, **MUSHARAF** & many more.

1st Dam: **FAZZAHA** (f, by Dahman El Arami) Dam of:

- DA'AREEN** (f, by Bibi De Carrere) **5 wins** & 21 places
- GHALIB** (c, by Munjiz) **4 wins** & 15 places, **1st** Prix Cheri Bibi (**Gr.2**), 2nd Prix Tidjani (**Gr.3**), 3rd Qatar Total Arabian Trophy (**Gr.1**).
- NAJMAAH** (f, by Sire D'Albret) **1 win** & 3 places. 5th Prix de L'Elevage (**Gr.2**).
- QADER** (c, by Munjiz) **5 wins** & 3 places
- RASIKH** (c, by Sire D'Albret) **5 wins** & 10 places, 2nd Coupe de France des Chevaux Arabes (**Gr.1**).
- YARAA** (f, by Sarrab) **3 wins** & 4 places, 2nd French Arabian Breeders Challenge (**Gr.2**).
- HADY** (c, by Saklawi Jadrane) **1 win** & placed from 2 starts, incl: 4th Coupe de France des Chevaux Arabes (**Gr.1**).

2nd Dam: **VERMEILLE** (f, by Manganate) 4 places from 8 starts, Dam of:

- FANDIM** (g, by Bibi De Carrere) **2 wins** & 3 places
- Fatenah (Regal De Khan) once 3rd place from 6 starts, Dam of:
 - BH FATAN** (g, by Al Reef) **1 win** & 3 places in UAE.
- Shaiyka (f, by Sire D'Albret) unplaced, Dam of:
 - NARJES** (f, by Munjiz) **1 win** & 7 places, 5th Prix Razzia III (**Gr.3**).

3rd Dam: **WARKA** (f, by Navar) unraced. Dam of:

- WAARH** (f, by Djamel) **1 win** & 2 places
- WAPITIE** (f, by Manganate) **4 wins** & 7 places. Dam of:
 - WALL STREET** (c, by Zacan El Baraka) **3 wins** & 14 places
- VERT MOUSSE** (f, by Djelfor) **2 wins** & 5 places
- VERT GALANTE** (f, by Dunixi) **5 wins** & 14 places. Dam of:
 - VERDORA** (c, by Dormane) **2 wins** & 7 places.

No:32

R.S KASHKA (AE)
Grey, Stallion
05/04/2004

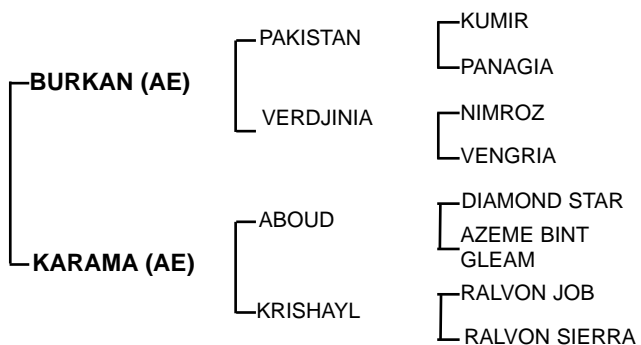

Sire: **BURKAN** (c, by Pakistan).

1st Dam: **KARAMA** (f, by Aboud).

No:33

KHADIJA (AE)
Chestnut, Mare,
11/03/1998

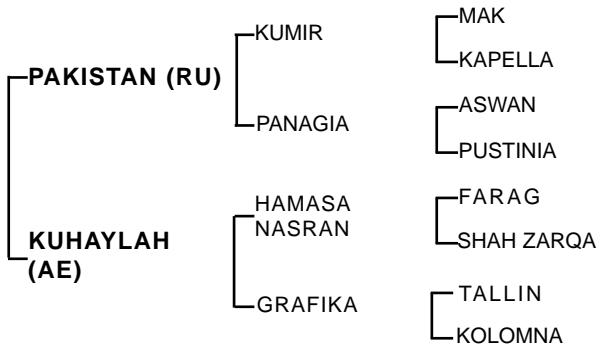

Sire: **PAKISTAN** (c. by Kumir)

1st Dam: **KUHAYLAH** (f. by Hamasa Nasran)

No:34

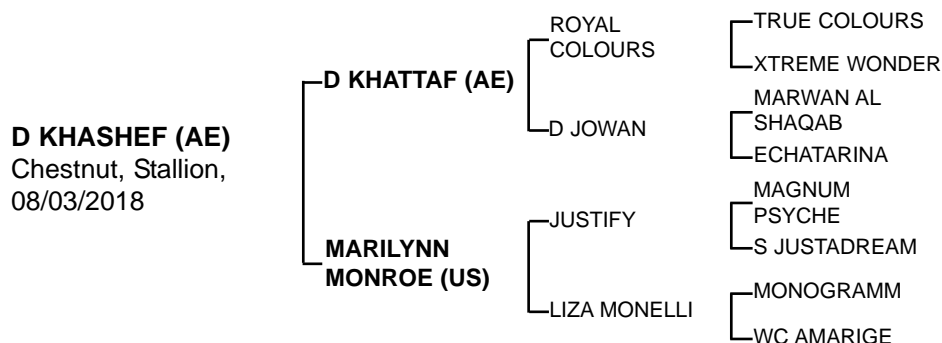

Sire: **D KHATTAF** (c, by Royal Colours)

- GOLD CHAMP** at Bergamo 2017 - Senior Stallions Championship (Class 23)
- SILVER CHAMP** at WELS 2017 - Int'l Senior Stallion Championship (Class 21)
- BRONZE CHAMP** at SHARJAH 2017 - Stallions Championship (Class 16)
- SILVER CHAMP** at Dubai 2016 - Colts Championship (Class 21)
- GOLD CHAMP** at Sharjah 2016 - Colts Championship (Class 14)
- GOLD CHAMP**.: Senior Stallions, Emirates - Breeders Championship 12/2016
- 3rd at Menton 2015 - Colts 3 years old (Class 8)
- 3rd at Dubai 2015 - Colts 2 years (Class 10)
- SILVER CHAMP** at Sharjah 2015 - Champ: Junior Colts (Class 23)
- GOLD CHAMP**: Junior Colts, Sharjah - Local Bred Festival 12/2014
- BRONZE CHAMP**, All Nations Cup 2014 - Championship Junior stallions
- 2nd at Menton 2014 - Colts 2 years (Class 7)

1st Dam: **MARILYNN MONROE** (f, by **JUSTIFY** - AHBA Vegas Futurity Stallion, Sweepstakes Nominated Sire, MAHB Nominated Sire, Scottsdale Signature Nominated Sire, IA Gold Star Stallion). Dam of:

- D SUROUR** (c, by FA El Rasheem)
 - Silver Champ** - Yearling Colts - Kuwait National Championship 2017
- D LAMAR** (f, by FA El Rasheem)
 - Silver Champ** - Junior Fillies - 7th National Championship Kuwait 2018

2nd Dam: **LIZA MONELLI** (f, by **MONOGRAMM** (c, by Negatraz) -

- US National Reserve Champion Futurity Colt**
- US National Top Ten Stallion**
- Regional Champion Stallion**
- International Sire of Significance)**

No:35

R.S KHATTAR (AE)
Chestnut, Stallion,
04/03/2004

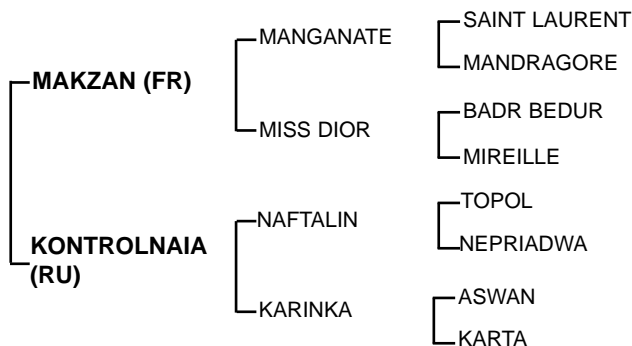

Sire: MAKZAN (c, by Manganate) **19 wins** & 17 places from 41 starts. **winning** incl: **1st** Qatar Sprint Championship (6 furlong), Emirates Sprint (5 furlong), Zaabeel Stakes (6 furlong), Stakes International Turf (1700 m), Abufas Stables Cup (1800 m), HH Sheikh Abdullah's Sword (2400 m), P/A Derby (1800 m), Wajba Cup (2400 m) sire of **winners** incl: **ROBBIE** (out of Naira) **5 wins** & places, **PIGARO** (out of Piroga) **6 wins** & places, **CS PATRIARCH** (out of Pokrovka) **4 wins** & places, **MAGS MAD MAX** (out of Darling Dorra) **4 wins** & placed, **MIQDAM** (out of Las Apposionata) **5 wins** & placed.

1st Dam: **KONTRILNAIA** (f, by Naftalin) **1 win** & 2 places from 4 starts in UAE. **Half Sister** to **DRUG** (c, by Prizrak) a great racehorse, **35(13-9-3)** incl, **Russian, Derby**, the Elite and placed 2nd in great summer Prize, SM Budenny, the Elite Also raced in France and UK, **winner** of couple d'Europe du Cheval Arabe. Dam of:
RS KERIM (g, by Bibi de Carrere) **6 wins** & 5 places
RS KHAAN (c, by Ezil) **2 wins** & 6 places in UAE.

No:36

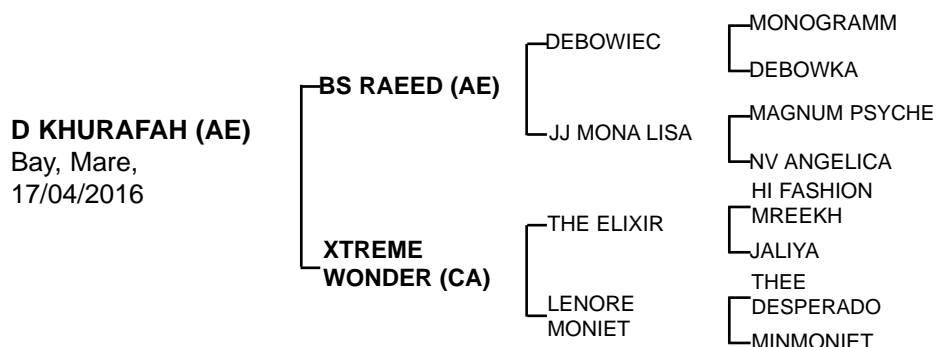

D KHURAFAH - Half Sister to ROYAL COLOURS

Sire: **BS RAEED** (c, by Debowiec)

GOLD CHAMPION - Ajman Arabian Horse Show

BRONZE Yearling Colt - The Ajman 2013 Arabian Horse Show

2nd - Class of Yearling Colts - DIAHC - 2013

3rd 2yo Colts - H.H. Sh. Sultan bin Zayed Al Nahyan 8th Int'l Festival

4th Class Colts - UAE National Arabian Horse Championship 2013.

Sire of:

D ABRAQ -

Bronze Champion - 2nd Bahrain Int'l Show 2018

SILVER Champion - 8th Bahrain National Festival 2017

SAAD AL AALYA -

Bronze Champion - Emirates Breeders Championship 2017

1st Dam: **XTREME WONDER** (f, by **THE ELIXIR** - Canadian Nationals, and Scottsdale, Top 10 Stallion, along with several Championships, and Reserves at the Egyptian Event. He also has numerous Regional Championships). Dam of:

ROYAL COLOURS - The World Platinum Champion Stallion.

2009 **Senior Champion Stallion** - Dubai International Championship

2009 **World champion stallion** - World Championship

2006 **World Champion Colt** - World Championship, Paris

2006 **Reserve Champion Colt** - Aachen, Germany.

Sire of **D KHATTAF, D HAYDAR, PSE RASHEEKAH, D MONAF, PSE RAKHAN, D MARAKSH, ABHA KAREEM, CS IZAZ ASAYL, AD MAGIC COLOURS, KHADIJA BY KHALILA, D FAAIQ** & many more.

ROYAL EMIRA (f, by True Colours) Dam of:

D OMNIA - GOLD Champion Mare - Sharjah S.E Festival 2017

D SEENEYYAH - GOLD Champion Senior Female - Al Shira'a Int'l 2020

GOLD Champion Senior Female - Ajman Show 2020

GOLD Champion Junior Filly - Austrian Int'l ECAHO Championship 2019

GOLD Champion Junior Female - Arabian Dream 2019.

D WASAYEF - GOLD Champion Yearling Filly - Austrian Int'l 2017

GOLD Champion Yearling Filly - West Coast Cup 2017

D BAREQ - GOLD Champion Yearling Colt - Sharjah Int'l Festival 2018

D AMEEREYYAH - GOLD Champion Junior Female - S.E. Show 2019.

No:37

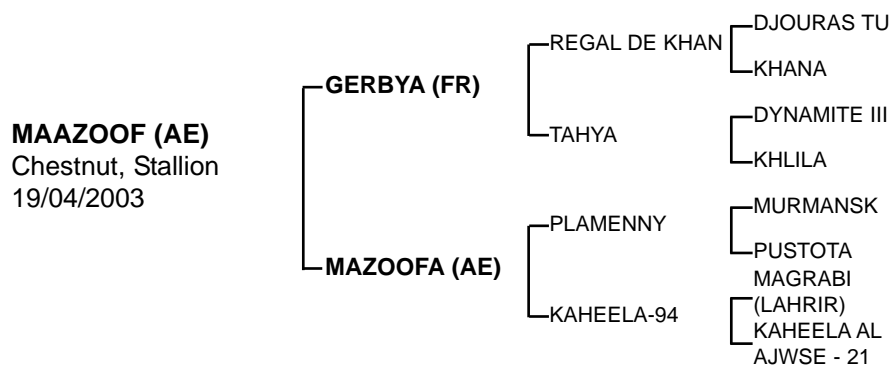

Sire: GERBYA (c. by Regal de Khan) **3 wins**, 2nd (4 times) & placed 3 times in UAE. Rate 117 **winning** incl: **1st** Newmarket Race Course Trust HCP, **1st** H.H.Sh Khalifa Bin Zayed Al Nahyan Triple Crown Round III, **1st** H.H.Sh Khalifa Bin Zayed Al Nahyan Triple Crown Round I & 2nd Kahayla Classic, 2nd Adnoc Distribution HCP. Earned Prize more than **345,000** AED. Sire of **many winners**.

1st Dam: **MAZOOFA** (f, by Plamenny) Dam of:
MAZOOF II (c, by Tahar De Candelon) **1 win** & 3 places from 4 starts.

No:38

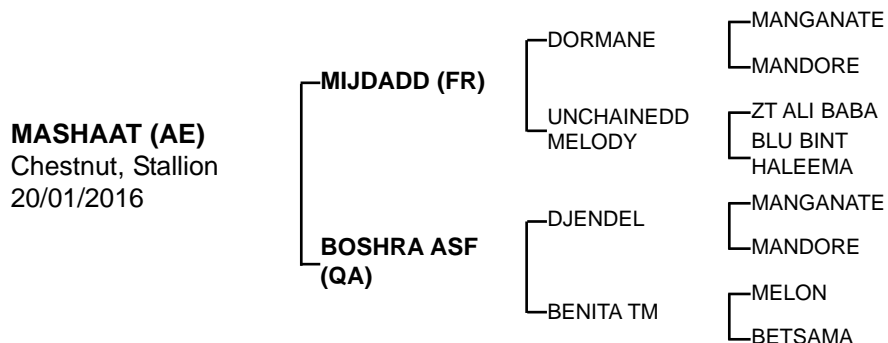

Sire: **MIJDADD** (c, by Dormane) **2 wins** at 4& 5yo and 5 places in UAE. 3rd HH Sh. Khalifa bin Zayed Al Nahyan Triple Crown R3 (**Gr.3**). **Full Brother** to **GABRA** - **3 wins** & 9 places, **Half Brother** to **MIZZNA** (f, by Akbar) **10 wins** in **Gr.1, Gr.2, Gr.3** races & 5 places, **MUNJIZ** (c, by Kesberoy) **1 win** & 4 places from 6 starts. Sire of: **GHAITH** - **1 win** & 3 places in UAE, **SAMIHA** (2015) 4 places in UAE, **SEE BIRD AL MAURY** (2015) 2 places from 2 starts in France, incl: 3rd Prix Cheri Bibi (**Gr.3**), **FLIC FLAC AL MAURY** (2016) 5th Prix Tidjani (**Gr.3**) in France.

1st Dam: **BOSHRA ASF** (f, by **DJENDEL** (c, by Manganate) **5 wins** & 1 place from 7 starts. Full brother to **DORMANE, DJAMEL, MADJEL, MARGAU**, sire of many winners incl: **ARA DECIEL, DJENDEL DAHL, BARARI** & many more).

2nd Dam: **BENITA TM** (f, by Melon) **5 wins** & 3 places in USA,UK & in Qatar, Dam of: **JABAR ASF** (c, by Parador) **3 wins** & 31 places in Qatar **BARIQ AL SAYF** (c, by Arawak D'Aroco) **4 wins** & 12 places in Qatar & in UAE, **1st H.H.Sh Khalifa bin Zayed Al Nahyan Tripple Crown R2 (Gr.3)**, 3rd H.H.Sh Khalifa bin Zayed Al Nahyan Tripple Crown R1 (**Gr.3**). **BADI'AH** (c, by Arawak D'Aroco) **1 win** & 5 places in Qatar **BARARI** (c, by Djendel) **5 wins** & 6 places, Top Sprinter. Becquerel (f, by WF High Voltage) unraced, Dam of: **DALAL AL HANA** (f, by Djendel) **1 win** & 10 places.

3rd Dam: **BETSAMA** (f, by Samtyr) unraced, Dam of: **MELLONAH** (f, by Melon) **2 wins** & 12 places, Dam of: **BIG DOG DADDY** (g, by Falina Des Fabries) **2 wins** & 4 places **WHOS MY DADDY** (f, by Haffir El Jamal) **5 wins** & 13 places **SCOOT** (f, by Falina Des Fabries) **8 wins** & 7 places, **1st Arabian Cup Juvenile Fillies S. (Gr.1)**, 3rd Cre Run Oaks (**Gr.1**). **WHOS YOUR DADDY** (f, by The Fast Line) **9 wins** & 24 places, 2nd Arabian Cup Championship Juvenile Fillies S. (**Gr.1**), 3rd Buss Brauning Distaff Stakes (**Gr.1**), 3rd Cre Run Oaks (**Gr.1**). **NO SHOW JONES** (g, by Virgule Al Maury) **15 wins** & 13 places, 3rd Arabian Cup Championship Juvenile Fillies S. (**Gr.1**). **ORZELDA** (f, by SMR Ibn Orzel) **1 win** & once 2nd placed. Dam of: **ZING AWAY** (g, by Flaming Streak) **8 wins** & 12 places. **MELLONEE** (f, by Melon) **1 win** & 5 places. Mellodee (f, by Melon) unraced, Dam of: **BE-MELLOW** (g, by Bekas) **1 win** & 5 places.

No:39

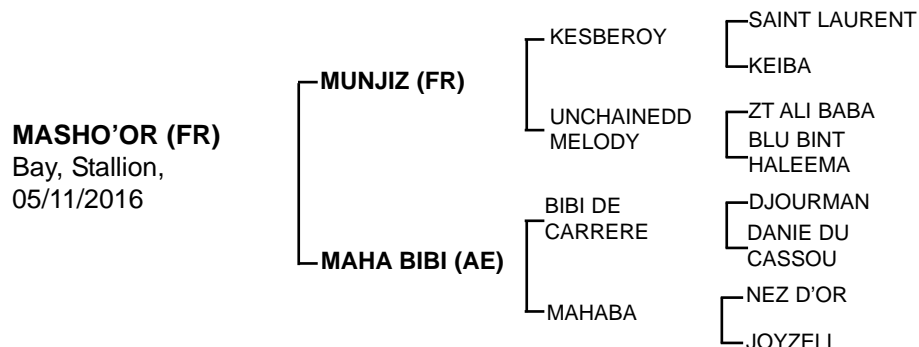

Sire: **MUNJIZ** (c, by Kesberoy) **1 win** & 4 places from 6 starts. **winner** of: Prix du President des Emirats Arabes Unis - Challenge Derby (**Gr.1**), 2nd Prix de Carthage (**Gr.2**), 3rd Prix du Haras de Gelos. **Half brother** to **MIZZNA**, **MIJDADD**. Sire of **winners** incl: **JOSCO DU CAUROU**, **GHALIB**, **SAHLAMBO**, **MUNZADE**, **MYRA DE MONLAU**, **AAKIF**, **AL MAMUN MONLAU**, **AWAM**, **ELYAAH**, **AL BASHTOON**, **MISTER DU LOUP**, **MELK**, **FANTASY MISS**, **LADY WISH**, **MISS FANTASIA**, **MASCATE**, **GHADEER**, **KARLOS DU CAYROU**, **ZAKHO**, **THABIT**, **BANDAR**, **NAJAH**, **YATHRIB**, **MUNOWRA**, **AUSTRALYA**, **SOMOUD**, **ESKANDAR**, **BASEEL**, **DUZAR**, **MUNZADE**, **CANDAHAR**, **MUSHARAF** & many more.

1st Dam: **MAHA BIBI** (f, by Bibi De Carrere) once 3rd placed from 2 starts, Dam of:
Ha'asoom (f, by Saklawi Jadrane) 4 places from 6 starts.
Samid (2017 c, by Munjiz) Under Training in France
Muraqib (2017 c, by Munjiz) Under Training in France.

Her sire **BIBI DE CARRERE** (c, by Djourman) **8 wins** and 6 places from 17 starts at 3- 5yo in France & UAE, Sire of **many winners** incl: **RABBAH DE CARRERE** - **5 wins** & 5 places, **DYNAMITE** - **10 wins** & 23 places - The First Local bred in the History of Arabian Racing to winner of HH The President Cup (**Gr.1**), **NAHEE** - **4 wins** & 4 places, **CARAT** - **4 wins** & 8 places, **SHA'RED** - **2 wins** & 5 places, **MARZOOQ** - **2 wins** & 1 place, **RS KERIM** - **6 wins** & 3 places, **SAKEN** - **8 wins** & 6 places & among others.

2nd Dam: **MAHABA** (f, by Nez D'or) unraced, Dam of:
EL GHOUL (c, by Saklawi Jadrane) **winner** in UAE.
KARDOOS (c, by Saklawi Jadrane) **1 win** & 7 places, 3rd French Arabian Breeders Challenge (**Gr.3**)
SHAJARET EDDOR AL REEF (f, by Scharly) **1 win** & 18 places, Dam of:
SALAF (c, by Munjiz) **1 win** & once 2nd placed.
MUSHEER AL WATHBA (c, by Tahar De Candelon) **2 wins** & 2 places
SHAWALL (g, by Bibi De Carrere) **1 win** & 13 places

3rd Dam: **JOYZELL (MAHA)** (f, by Jaf Orphatyn) **Sprint Champion, Highest Race record** in USA & UAE. **29 wins** from 29 races since 3yo to 10yo. **Champion** in UAE **25 wins** for 25 races, **Top Rating** - **140**. **World Record** 1000m record - Abu Dhabi: **1.02:06** & 1200m record - Abu Dhabi: **1.16:67**. .Dam of:
LAHAB (c, by Tahar de Candelon) **3 wins** & 6 places in UAE,
MAHABB (c, by Tahar de Candelon) 8 races, **5 wins** & 3 places at 4-5 in France & England - **\$41,071**, winning incl: **1st Prix Nefta (Gr.2)**, **1st Prix Damas (Gr.3)** - **Sire**.

No:40

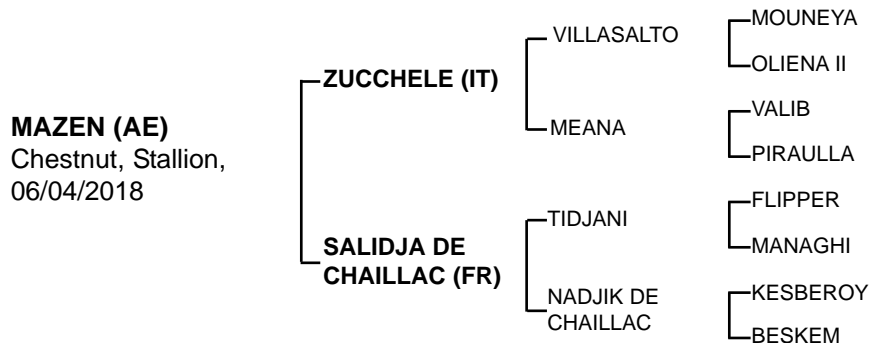

Sire: **ZUCCHELE** (c, by Villasalto) 2 places from 5 starts. Sire of:
TORNADO BY ZUCCHELE - 5 wins & 3 places in Italy
SIRIO BY ZUCCHELE - 1 win & once 3rd placed from 2 strats.
ZARINA BY ZUCCHELE - 1 win & once 2nd placed.

1st Dam: **SALIDJA DE CHAILLAC** (f, by Tidjani) unplaced, Dam of:
AKBAR L'ATLAS (c, by Akbar) 5 wins & places in Morocco, 1st Prix du Jockey Club of Turkey.
 Adlah (2018 f, by Zucchele)
 Zinet (2018 f, by Zucchele)
 Sareeha (2018 f, by Rabbah De Carrere)
 Basem Al Wathba (2019 c, by Mijdadd)
 Radhwa Al Wathba (2019 f, by Mijdadd)
 Razan Al Wathba (2019 f, by Raaziq)

2nd Dam: **NADJIK DE CHAILLAC** (f, by Kesberoy)
 Thalem De Chaillac (f, by Djel Bon) 4 places in UAE, 2nd Wathba Stud Farm Cup.
 Vahess De Chaillac (c, by Dahess) 2 places at 3. 3rd Prix Dunixi, 4th Prix du 7'eme Spahis.

3rd Dam: **BESKEM** (f, by Besbes) unraced, Dam of:
MESKADO DE CHAILLAC (c, by Tornado de Syrah) 10 wins & 6 places, 2nd GP de SAR Mohamed VI (Gr.3) - **Stallion**
LEEROY DE CHAILLAC (c, by Kesberoy) 8 wins & 1 placed - **Stallion**
JESROY DE CHAILLAC (c, by Kesberoy) 1 win & 7 places - **Stallion**
 Kesbes De Chaillac (f, by Kesberoy) 7 places in Qatar & in UAE - **Broodmare**.
 Orwane De Chaillac (f, by Dorwan Du Cayrou) unraced, Dam of:
AKHO AMYR EVENT (c, by Darweesh) **winner** & placed in Morocco, 1st Grand Prix Monlay Ismail, 2nd HH Sheikha Fatima Bint Mubarak Apprentice World Championship, 3rd Grand Prix Monlay Abdellah (L.PA).

No:41

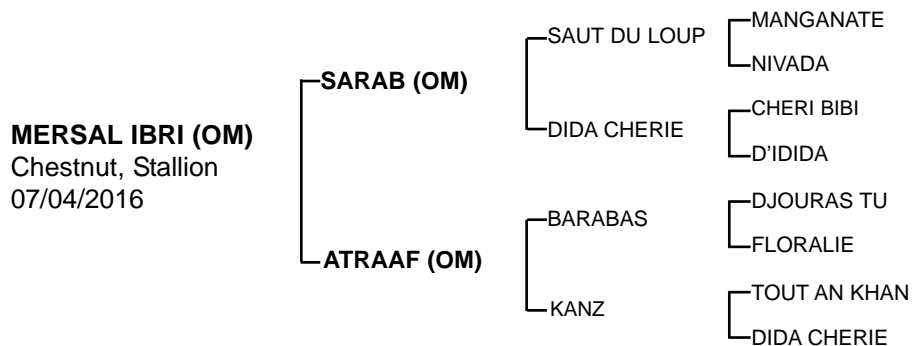

Sire: **SARAB** (c, by Saut Du Loup)

1st Dam: **ATRAAF** (f, by **BARABAS** (c, by Djouras Tu) **1 win** & placed from 2 strats, **Half Brother** to **TOUT AN KHAN** (c, by Dahman El Arami) **4 wins** & 3 places).

2nd Dam: **KANZ** (f, by **TOUT AN KHAN** (c, by Dahman El Arami) **4 wins** & 3 places, **Half Brother** to **BARABAS** (c, by Djouras Tu) **1 win** & placed from 2 strats).

3rd Dam: **DIDA CHERIE** (f, by Cheri Bibi) **Mare of the year** in 1990. 41 starts, **11 wins** & placed 24 times. **Winner** in Evry & in Kempton Park. **Full sister** to - **AMIRA D'ALBRET, DAY AL MAURY, MALIKA D'ALBRET** & **Half sister** to **DON DU CIELAL MAURY**.

No:42

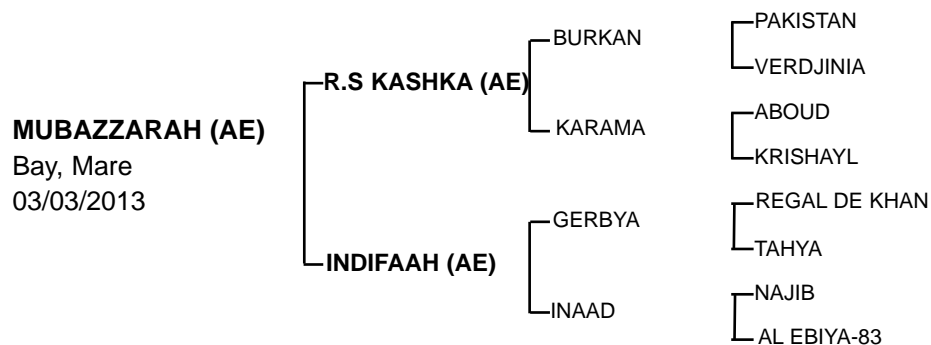

Sire: **R.S KASHKA** (c, by Burkan).

1st Dam: **INDIFAAH** (f, by **GERBYA** (c. by Regal de Khan) **3 wins**, 2nd (4 times) & placed 3 times in UAE. Rate 117 **winning** incl: **1st** Newmarket Race Course Trust HCP, **1st** H.H.Sh Khalifa Bin Zayed Al Nahyan Triple Crown Round III, **1st** H.H.Sh Khalifa Bin Zayed Al Nahyan Triple Crown Round I & 2nd Kahayla Classic, 2nd Adnoc Distribution HCP. Earned Prize more than **345,000 A.E.D** - Sire of many **winners**.

No:43

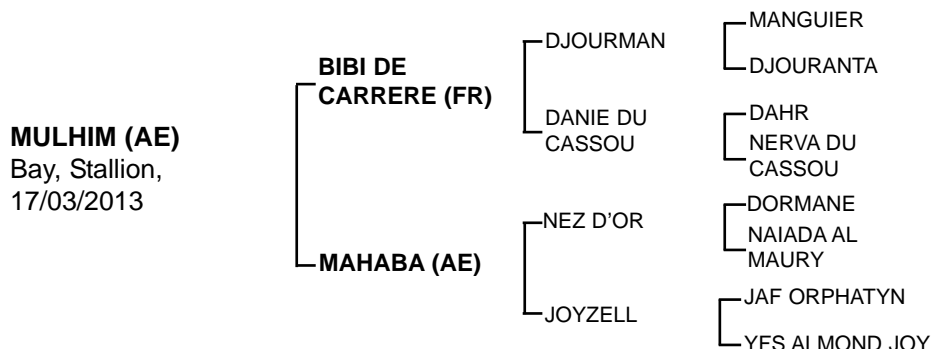
**MULHIM - 1 win & 4 places. Official Rating: 42**

Sire:**BIBI DE CARRERE** (c, by Djourman) **8 wins** and 6 places from 17 starts at 3- 5yo in France & UAE, Sire of **many winners** incl: **RABBAH DE CARRERE - 5 wins & 5 places**, **DYNAMITE - 10 wins & 23 places** - The First Local bred in the History of Arabian Racing to winner of HH The President Cup (**Gr.1**), **NAHEE - 4 wins & 4 places**, **CARAT - 4 wins & 8 places**, **SHA'RED - 2 wins & 5 places**, **MARZOOQ - 2 wins & 1 place**, **RS KERIM - 6 wins & 3 places**, **SAKEN - 8 wins & 6 places** & among others.

1st Dam: **MAHABA** (f, by Nez D'or) unraced, Dam of:

EL GHOUL (c, by Saklawi Jadrane) **winner** in UAE.

KARDOOS (c, by Saklawi Jadrane) **1 win & 7 places**, 3rd French Arabian Breeders Challenge (**Gr.3**)

SHAJARET EDDOR AL REEF (f, by Scharly) **1 win & 18 places**, Dam of:

SALAF (c, by Munjiz) **1 win & once 2nd placed**.

MUSHEER AL WATHBA (c, by Tahar De Candelon) **2 wins & 2 places**

SHAWALL (g, by Bibi De Carrere) **1 win & 13 places**

2nd Dam: **JOYZELL (MAHA)** (f, by Jaf Orphatyn) **Sprint Champion, Highest Race record** in USA & UAE. **29 wins** from 29 races since 3yo to 10yo. **Champion** in UAE **25 wins** for 25 races, **Top Rating - 140. World Record** 1000m record - Abu Dhabi: **1.02:06** & 1200m record - Abu Dhabi: **1.16:67**. .Dam of:

LAHAB (c, by Tahar de Candelon) **3 wins & 6 places** in UAE,

MAHABB (c, by Tahar de Candelon) 8 races, **5 wins & 3 places** at 4-5 in France & England - **\$41,071**, winning incl: **1st Prix Nefta (Gr.2)**, **1st Prix Damas (Gr.3)**. Sire of **many winners**.

3rd Dam: **YFS ALMOND JOY** (f, by YF El Damir) unraced, Dam of **winners** incl:

JUSTAJOOY (c, by Brusally Orlen) **1 win & 4 places** from 6 starts in USA

Justonetime (f, by Brusally Orlen) Unraced, Dam of **winner's** incl:

NO REPEAT (c, by Wiking) **2 wins & 9 places** in USA

IN SINGLE (f, by Wiking) **1 win & 5 places** in USA

ONE OF US (c, by Vadeer) **4 wins & 5 places** in USA

ONCET (g, by Tomanchie) **3 wins & 7 places** in USA

Sarha (f, by T C Tomtyr) Unraced, Dam of **winner** incl:

FILSD CROIXNOIRE (c, by Ala Croixnoire) **3 wins & 10 places**

NARAA (f, by Calin de Louve) **1 win & once 2nd** from 2 starts

DIRHAM EXPRESS (f, by TC Tomtyr) **2 wins & 10 places** in USA.

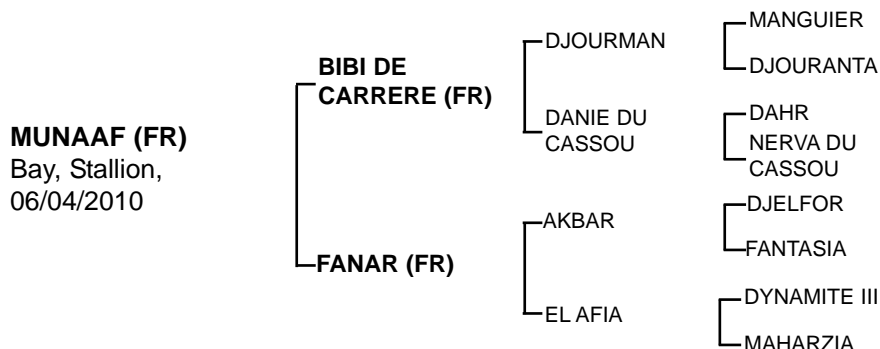
No:44

MUNAAF - 4 wins & 11 places in UAE.

Sire:**BIBI DE CARRERE** (c, by Djourman) **8 wins** and 6 places from 17 starts at 3- 5yo in France & UAE, Sire of **many winners** incl: **RABBAH DE CARRERE - 5 wins & 5 places**, **DYNAMITE - 10 wins & 23 places** - The First Local bred in the History of Arabian Racing to winner of HH The President Cup (**Gr.1**), **NAHEE - 4 wins & 4 places**, **CARAT - 4 wins & 8 places**, **SHA'RED - 2 wins & 5 places**, **MARZOOQ - 2 wins & 1 place**, **RS KERIM - 6 wins & 3 places**, **SAKEN - 8 wins & 6 places** & among others.

1st Dam: **FANAR** (f, by Akbar) unraced, Dam of:

DAHAM (c, by Mahabb) **3 wins & 5 places** in France & in UAE, incl: **1st** Qatar Coupe de France des Chevaux Arabes (**Gr.1**), Prix Kesberoy (**Gr.1**), 3rd H.H. The President Cup (**Gr.1**).

SHATEH (c, by Mahabb) **4 wins & 10 places** in France & in UAE, incl: **1st** Al Ruwais (**Gr.3**), 2nd Liwa Oasis (**Gr.1**), Bani Yas (**Gr.2**), Sh. Zayed bin Sultan Al Nahyan Cup (**Gr.3**).

2nd Dam: **EL AFIA** (f, by Dynamite III) **Full Sister** to **BERREZIG**, Dam of **winner** incl:

LAAMMA (c, by Munjiz) **2 wins & 6 places** in France & UAE, **1st** Arabian Triple Crown R2 in Abu Dhabi (**Gr.3**).

ABHAAR (c, by Tidjani) **1 win & 3 places**.

HIDERNE DE FAUST (f, by Tornado de Syrah) **2 wins & 5 places** in UK & UAE. 3rd The Hatta International Stakes (**Gr.1**)

JAWASS (c, by Dormane) **2 wins & 6 places**, 3rd Arabian Triple Crown II (**Gr.3**)

HABAIB (f, by Al Sakbe) **2 wins & 5 places**

Hafia de Faust (f, by Tidjani) unraced, Dam of:

HELLOW (c, by Kesberoy) **2 wins & 7 places**

HAMOUR (c, by Akbar) **3 wins & 4 places**

HAGNES DE FAUST (f, by Dormane) **2 wins & 2 places** in France & UAE, Dam of:

QIRFA DE FAUST (f, by Al Sakbe) **1 win & 3 places** in Morocco, 4th Grd Prix de SAR Le Prince Moulay Rachid (**Gr.1**)

SHAKIB DE FAUST (c, by Prince d'Orient) **1 win & 3 places**

VOLGA DE FAUST (f, by Munjiz) **2 wins & 4 places**.

3rd Dam: **MAHARZIA** (f, by Sibawain) 3 places from 3 starts, Dam of :

BERREZIG (c, by Dynamite III) **7 wins & 15 places** in Tunisia & Italy

HALFAOUINE (f, by Dynamite III) **2 wins & 3 places**. Dam of:

TURKAN TAJ (f, by Dormane) **2 wins & 4 starts**.

No:45

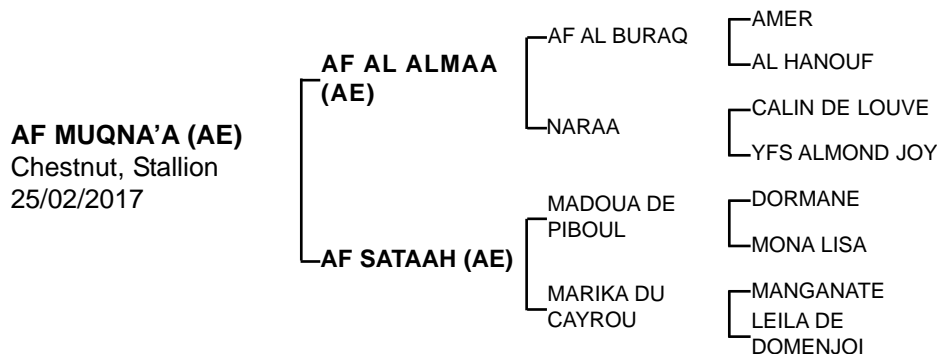

AF MUQNA'A - once 3rd & once 4th placed from 4 starts. **Official Rating:42**

Sire: **AF AL ALMAA** (c, by AF Al Buraq) **2 wins** & 14 places, His sire **AF AL BURQA** (c, by Amer) once 3rd place from 1 start. **FULL BROTHER** to **AF ALBAHAR**. sire of **Stakes winners** and performers. some of best progeny incl: **AF MAHER** (Dubai Kahayla Classic (Gr.1), **AF MAQAYES** (Al Ruwais (Gr.3), **AF AL HAZER** - Arabian Triple Crown R1, **AF AL SAJANJLE** - (Mazrat Al Ruwayah (Gr.2), **AF TAWAQ** - (2nd Al Maktoum Challenge R3 (Gr.1), **AF ALWAJEL** - (2nd Al Ruwais Stakes (Gr.3), **AF MAHSHOUM** - (Sheikh Zayed bin Sultan Al Nahyan National Day Cup (Gr.3), **AF AL ALMAA**, **AF AL JAHED**, **AF ASHRAS**, **AF HAKEEM**, **AF LA'ASAE**, , **AF SSAYEB**, **AF THOBAR**, **AF AL ASEF**, **AF AL SALLY**, **AF ASHEHAM**, **AF BAREQAH**, **AF KAFU**, **AF MADRUB**, , **AF MASHAREF**, **AF MONSEF**, **AF MUKHIFAH**, **AF TARAHA**, **AF TEBYAN**, **AF YATROOQ**, **AJS BURQA**, **AF AL MEHLEB**, **AF AL BAHER**, **AF AL BAIRAQ**, **AF AMJAD**, **AF AL MOREEB**, **AF GADEER**, **AF MAFATEN**, **AF MAKERAH**, **AF MEGHWAAR**, **AF MOM-TAZ**, **AF MOTAGHATRES**, **AF MOUTHIRAH**, **AF WAQAS**, **AF MEZMAR**, **AF MEKHBAT**, **AF NAFECE**, **AF NOQOUSH**, **AF RAWIAH**, **AF SANAD**, **AF SHARESAH**, **AF THOBOR**, **AF TAREH AL THAHAB**, **AF TAGHZEL**, **AF YATROQ**, & many more.

1st Dam: **AF SATAAH** (f, by Madoua De Piboul) **1 win** & 5 places. His sire **MADOUA DE PIBOUL** (c, by Dormane), **7 wins** & 12 places incl: **The Emirates Arabian Stakes** at Newbury. 2000m, **The Emirates International Arabian Stakes** at Leicester. 1600m, **The Emirates Arabian International GP3** at Newbury. 2000m, **Tattersalls Open Conditions S Conditions** at Taunton. 1600m, **Emirates International Arabian Stakes** at Leicester & sire of **winners**.

2nd Dam: **MARIKA DU CAYROU** (f, by Manganate) unraced, Dam of **winners** incl:
AF JAMRR (c, by Danzinon) **2 wins**, 2time second & one placed
AF WEQAM (c, by Tidjari des Forges) Endurance Horse 40 / 100 KM in UAE
AF ESTIMRAAR (f, by Al Mori) **1 win** & once 5th from 3 starts. Dam of:
AF AL SALLY (f, by AF Al Buraq) **2 wins** & 2 places from 6 starts.

3rd Dam: **LEILA DE DOMENJOI** (f, by Sherkhan II) unraced, **Half Sister** to **ATUS DE DOMENJOI** (c, by Cheri Bibi) **5 wins** & 5 places, Dam of:
Ludmillah (f, by Dormane) unraced, Dam of:
LILLIJ ANN (f, by Makfoul du Breuil) **4 wins** & 5 places in Germany & Netherland, incl: 2nd Sheikh Zayed Al Nahyan Arabian Cup (Gr.3)
LIDJANI DE PALMAS (g, by Tidjani) **1 win** & once 3rd placed.

No:46

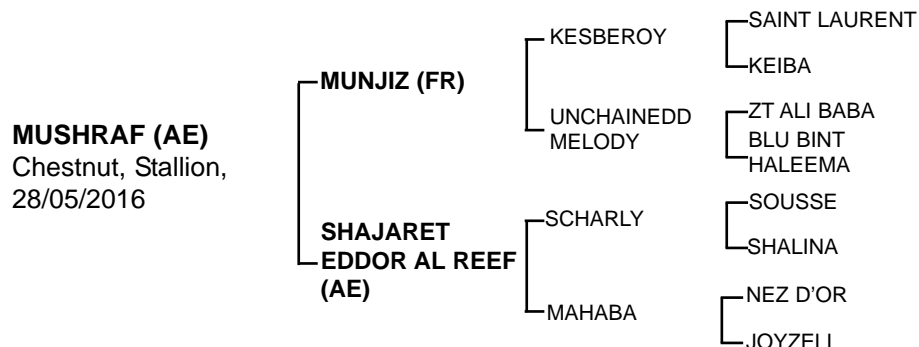

MUSHRAF - once 4th placed from 2 starts in France.

Sire: **MUNJIZ** (c, by Kesberoy) **1 win** & 4 places from 6 starts. **winner** of: Prix du President des Emirats Arabes Unis - Challenge Derby (**Gr.1**), 2nd Prix de Carthage (**Gr.2**), 3rd Prix du Haras de Gelos. **Half brother** to **MIZZNA**, **MIJDADD**. Sire of **winners** incl: **JOSCO DU CAUROU**, **GHALIB**, **SAHLAMBO**, **MUNZADE**, **MYRA DE MONLAU**, **AAKIF**, **AL MAMUN MONLAU**, **AWAM**, **ELYAAH**, **AL BASHTOON**, **MISTER DU LOUP**, **MELK**, **FANTASY MISS**, **LADY WISH**, **MISS FANTASIA**, **MASCATE**, **GHADEER**, **KARLOS DU CAYROU**, **ZAKHO**, **THABIT**, **BANDAR**, **NAJAH**, **YATHRIB**, **MUNOWRA**, **AUSTRALYA**, **SOMOUD**, **ESKANDAR**, **BASEEL**, **DUZAR**, **MUNZADE**, **CANDAHAR**, **MUSHARAF** & many more.

1st Dam: **SHAJARET EDDOR AL REEF** (f, by Scharly) **1 win** & 18 places, Dam of:
SALAF (c, by Munjiz) **1 win** & once 2nd placed.
MUSHEER AL WATHBA (c, by Tahar De Candelon) **2 wins** & 2 places
SHAWALL (g, by Bibi De Carrere) **1 win** & 13 places
Shamaah Al Wathba (2016 f, by Mijdadd) 4th placed from 2 starts.

2nd Dam: **MAHABA** (f, by Nez D'or) unraced, Dam of:
EL GHOUL (c, by Saklawi Jadrane) **winner** in UAE.
KARDOOS (c, by Saklawi Jadrane) **1 win** & 7 places, 3rd French Arabian Breeders Challenge (**Gr.3**)
MULHIM (c, by Bibi De Carrere) **1 win** & 4 places.

3rd Dam: **JOYZELL (MAHA)** (f, by Jaf Orphatyn) **Sprint Champion, Highest Race record** in USA & UAE. **29 wins** from 29 races since 3yo to 10yo. **Champion** in UAE **25 wins** for 25 races, **Top Rating - 140. World Record** 1000m record - Abu Dhabi: **1.02:06** & 1200m record - Abu Dhabi: **1.16:67**. .Dam of:
LAHAB (c, by Tahar de Candelon) **3 wins** & 6 places in UAE,
MAHABB (c, by Tahar de Candelon) 8 races, **5 wins** & 3 places at 4-5 in France & England - **\$41,071**, winning incl: **1st Prix Nefta (Gr.2)**, **1st Prix Damas (Gr.3)**, 2nd The Zaabeel International Stakes (**Gr.1**)(**X2**), 3rd French Arabian Breeder's Cup Mile (**Gr.1**) - **1200mtr record 1:16**, Sire of **many winners** incl: **MANARK**, **FAZAH**, **SARDAN**, **REKHA**, **MESTOR**, **AREEM SHATEH**, **AF HASBA**, **AF TATHOOR**, **TAYMOUR**, **JOORI**, **MEYDAN DU PAON**, **AF MO'ASSESS**, **ROCKMANE**, **SAUTERNES AL MAURY**, **THAKIF**, **CHALWA DU PAON**, **SHAHM**, **NASEEM**, **VISIONARY LADY** & many more.

No:47

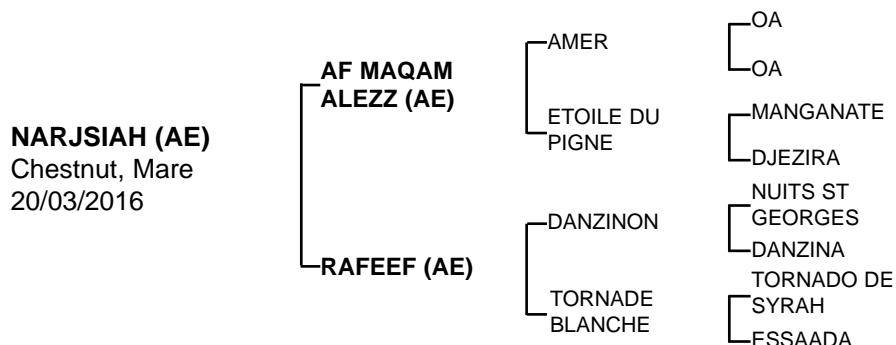

Sire: **AF MAQAM ALEZZ** (c, by Amer) **5 wins** & 7 places, **winning** incl: **1st** Wathba Stud Farm Cup (twice), **1st** Al Rehhan Handicap, 3rd Al Ruwais (**Gr.3**). **Full Brother** to **AF ATHHALATNI** - **4 wins** & 7 places. Sire of **winners** incl; **JAP YAJOUUD** - **4 wins** & 4 places, **AF AL AASSI** - **2 wins** & 8 places, **AF BARARI** - **2 wins** & 5 places, **AF MASS** - **1 win** & once 4th placed, **AF NASHRAH** - **1 win** & once 4th placed, **AF SHEAAR** - **winner**, **JAP AL KAHF** - **winner**, **JAP JAZMH** - **1 win** & 2 places, **JAP MALAWIH** - **1 win** & 7 places.

1st Dam: **RAFEEF** (f, by Danzinon) **1 win** from 6 starts in UAE. Her sire **DANZINON** (c, by **Nuits St Georges**) **6 wins** & 15 places in France, Qatar & UAE. **winning** incl: **1st** Prix Denouste (Toulouse - 7 furlong), Prix Djerba Oua (Agen - 1 meter), Prix Trophée du Président (Saint Cloud - 1meter), P/A Horses Colt & Stallions Cup (Doha - Qatar).sire of many **winners** incl:

LAZ"ZAZ ALFAISAL (out of FF Angel Wings) **3 wins** & placed
AF KANZ (out of Shirka) **1 win** & placed
AF JAMRR (out of Marika du Cayrou) **2 win**, 2nd twice & one placed,
AF INTEKHAB (out of Jawaher) **2 wins** & places
RS SHAH JAHAN (out of Sarahhana) **1 win** & 3 places.

2nd Dam: **TORNADE BLANCHE** (f, by Tornado de Syrah) **3 wins** & 5 places,

3rd Dam: **ESSAADA** (f, by Hosni) unraced, Dam of **winners** incl:

AL JAKBAR (c, by Al Sakbe) **2 wins** & 3 places, incl: Qatar Total French Arabian Breeder's Cup Mile (**Gr.1**) - **Sire**

SAINT AISSA (c, by Nuits St Georges) **6 wins** & 9 places in France & Belgium, The U.A.E Senior Sprint Championship

TORNADE BLANCHE (BINT BELADY) (f, by Tornado de Syrah) **3 wins** & 5 places - Al Asayl Championship (**Gr.3**), Dam of:

RAFEEF (c, by Danzinon) **winner** in UAE

ESSAANA (f, by Tornado de Syrah) **5 wins** & 4 places

TORNADOR (c, by Tornado de Syrah) **8 wins** & 16 places, La Coupe Goffs France (**Gr.1**), Prix Tornado de Syrah (**Gr.3**)

SPEED TORNADE (f, by Tornado de Syrah) **3 wins** & 4 places, Emaar Int'l Stakes (**Gr.2**), 3rd La Coupe Goffs France (**Gr.1**)

EZAYA (f, by Tornado de Syrah) **2 wins** & 6 places, 2nd Prix Razzia III (**Gr.3**)

ESSALDA (f, by Al Sakbe) **1 win** & 3 places in UK

KANJANI (c, by Madjani) **1 win** & 1 place in France.

No:48

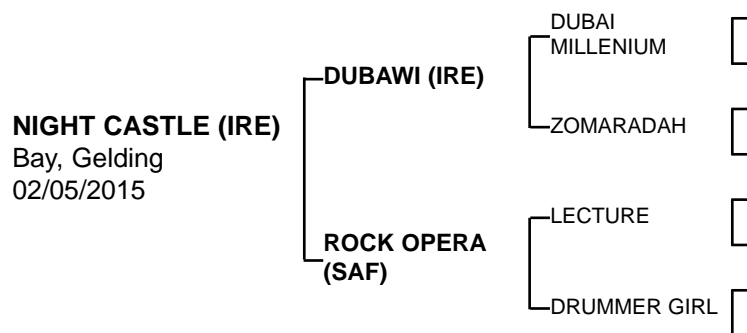
**NIGHT CASTLE - 3 wins & 4 places. Official Rating: 73**

Sire: **DUBAWI** (c, by Dubai Millenium) **5 wins & 2 places** from 8 starst. incl: **1st** National S (**G1**), 7f, Curragh, beating **Democratic Deficit**. **1st** Superlative S (**G3**), 7f, Newmarket, beating **Wilko**, **1st** Prix Jacques le Marois (**G1**), 8f, Deauville, beating **Whipper, Valixir, Divine Proportions**. **1s** tlrish 2,000 Guineas (**G1**), 8f, Curragh, beating **Oratorio, Democratic Deficit**. 2nd Queen Elizabeth II S (**G1**), 8f, Newmarket, to Starcraft, beating **Rakti**. 3rd Derby S (**G1**), 12f, Epsom, to Motivator, Walk In The Park, beating **Oratorio**. The fastest ever to sire **50 Group winners** and has more **Group winners** than any other stallion at the same stage in their careers. Sire of **23 G1 winners** so far. 15% **Stakes winners** and 10% **Group winners** from his first six crops makes him one of the world's greatest stallions. Sire of **MONTEROSSO, PRINCE BISHOP, LUCKY NINE, AKEED MOFEED, AL KAZEEM, NEW BAY, SRIKANDI, POSTPONED, HUNTER'S LIGHT, SECRET ADMIRER, NIGHT OF THUNDER, TIGER TEES, ARABIAN QUEEN, DUBAWI HEIGHTS, SAILORMAN** & among others.

1st Dam: **ROCK OPERA** (f, by Lecture) **4 wins & 2 places**, **1st** Allan Robertson Fillies Championship (**Gr.1**), Ascot Stud Fillies Nursery (**Gr.2**). Dam of:
HEAVY METAL (g, by Exceed And Excel) **15 wins & 11 places**, **1st** Al Maktoum Challenge R1 (**Gr.2**), Godolphin Mile (**Gr.2**), Burj Nahaar (**Gr.3**).
ROYAL MEETING (c, by Invincible Spirit) **2 wins & 2 places**
FRANKENFURTER (g, by Singspiel) **1 win & 11 places**.

THOROUGHBRED

No:49

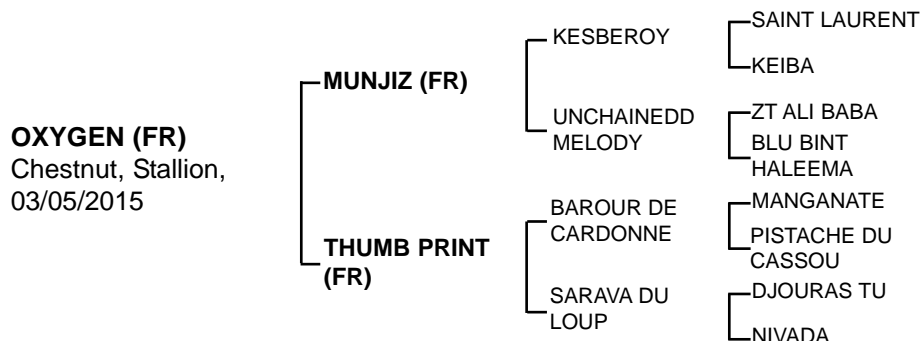

OXYGEN - 2 places from 2 starts in France.

Sire: **MUNJIZ** (c, by Kesberoy) **1 win** & 4 places from 6 starts. **winner** of: Prix du President des Emirats Arabes Unis - Challenge Derby (**Gr.1**), 2nd Prix de Carthage (**Gr.2**), 3rd Prix du Haras de Gelos. **Half brother** to **MIZZNA**, **MIJDADD**. Sire of **winner**s incl: **JOSCO DU CAUROU**, **GHALIB**, **SAHLAMBO**, **MUNZADE**, **MYRA DE MONLAU**, **AAKIF**, **AL MAMUN MONLAU**, **AWAM**, **ELYAAH**, **AL BASHTOON**, **MISTER DU LOUP**, **MELK**, **FANTASY MISS**, **LADY WISH**, **MISS FANTASIA**, **MASCATE**, **GHADEER**, **KARLOS DU CAYROU**, **ZAKHO**, **THABIT**, **BANDAR**, **NAJAH**, **YATHRIB**, **MUNOWRA**, **AUSTRALYA**, **SOMOUD**, **ESKANDAR**, **BASEEL**, **DUZAR**, **MUNZADE**, **CANDAHAR**, **MUSHARAF** & many more.

1st Dam: **THUMB PRINT** (f, by Barour De Cardonne) 2 places from 3 starts, Dam of: **VALIANT BOY** (c, by Darweesh) **12 wins** & 9 places, **1st** President of the UAE Cup Stakes (**Gr.1**) (**2013,2014**), Delaware Park Arabian Classic Handicap (**Gr.1**), Valour Farm Arabian Stakes (**Gr.2**), Bob Magness Memorial Arabian Derby (**Gr.2**), Arabian Racing Cup Stallion Stakes (**Gr.3**), Texas Arabian Derby (**Gr.3**), 2nd Dubai Kahayla Classic (**Gr.1**), Delaware Park Classic Handicap (**Gr.1**). **OXYGEN** (c, by Munjiz) **Subject Horse**.

2nd Dam: **SARAVA DU LOUP** (c, by Djouras Tu) unplaced. Dam of: **FRERE DES LOUP** (c, by Dunixi) **3 wins** from 5 starts
DENT DE LOUP (g, by Blaise) **9 wins** & 31 places
CROC DE LOUP (c, by Blaise) **2 wins** & 7 places.

3rd Dam: **NIVADA** (f, by Flipper) **2 wins** & 7 places Dam of:
SOPHIE DU LOUP (f, by Manganate) **10 wins** & 2 places. Dam of:
MUNTALIQ (c, by Izentespeshal) **2 wins** & 1 place
NEVADA DU LOUP (f, by Manganate) **3 wins** & 1 placed, Dam of:
SHAMEKHA (f, by Vadeer) **2 wins** & 15 places
NEMRAH (f, by Bibi de Carrere) **2 wins** & once 3rd place
SALIA DU LOUP (f, by Manganate) **1 wins** & 3 places. Dam of:
AKIM DU LOUP (c, by Darike) **1 win** & place
MAGIC DU LOUP (g, by Al Sakbe) **1 win** & 5 places
FAKIR DU LOUP (c, by Manganate) **2 wins** in UK
VANESSA DU LOUP (f, by Manganate) **California Champion Mare 20(4-8-5-2) 2-9**. Dam of **winner**s incl:
THOROUGHBRED (c, by TC Tomtyr) **11 wins** & 17 places
SILVERRADO (c, by TC Tomtyr) **7 wins** & 21 places.

No:50

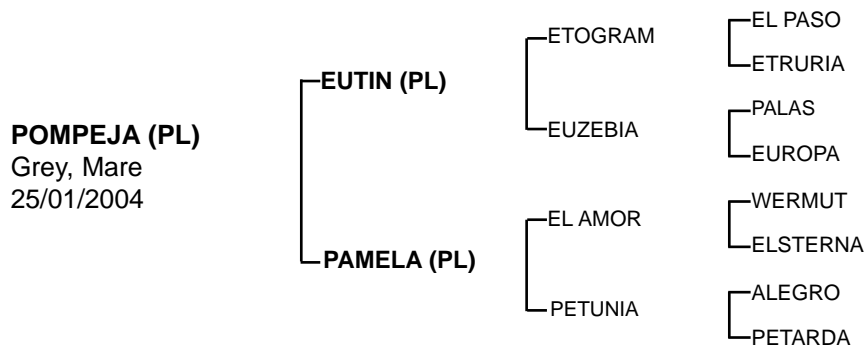

Sire: **EUTIN** (c, by Etogram)

5th 2 years old Class II - 1998

4th Stallions 4-6 years old - Poznan-Wola Show 2002

3rd Saddle Class - I Autumn Horse Show 2006

2nd Stallions 8 years & over - Autumn C Show 2007

4th Saddle Class - II Autumn Horse Show 2007

Her sire **ETOGRAM** (El Paso x Etruria) A **1981 Polish Arabian stallion** that was **Polish National Champion** along with being a fine sire.

1st Dam: PAMELA (f, by El Amour)

No:51

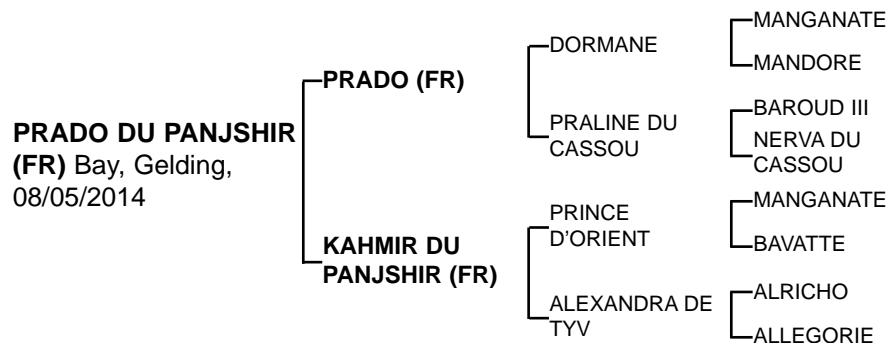

PRADO DU PANJSHIR - 3 wins & 4 places, Official Rating: 44

Sire: **PRADO** (c, by Dormane) **6 win** & 14 places, incl: Sprinter Championship (**Gr.3**), **FULL Brother** to **PARADOR - 11 wins** (Al Maktoum Challenge R3 (**Gr.1**) & **Half Brother** to **KERRA** (f, by Kesberoy) **13 wins** (Coupe d'Europe du Cheval Arabe (**Gr.1**), Int'l Arabian Cup Distaff (**Gr.2**)). His sire **DORMANE** (c, by Manganate), Bred in France. He raced as a 3 and 4 year old and had **six wins**. He is own brother to **Djamel, Madjel, Djenbel**, and **Margau** Dam of **Massamarie**. **Dormane** is the **Championship sire** of his generation and is sire of **winners** including, **Dorwan Du Cayrou, Passem Lotois, Darike, Chndaka, Chaikh Man, Noreen, Nisaee**.

1st Dam: **KAHMIR DU PANJSHIR** (f, by **PRINCE D'ORIENT** (c, by Manganate) **2 wins** & 1 placed from 3 starts, **winning** ncl: **1st Prix ADNOC LUBE (Champion** at Int'l Des Trois Ans), **1st prix du President Des Emirates Arabs Unis (Course C)**, sire of many **winners** incl: **JESILK, L'ORIENTALE, PRINCE DORMANT, SHAKIB DE FAUST, TASHKANDI, AKKAR, REBELLE DE FAUST** & others)

2nd Dam: **ALEXANDRA DE TYV** (f, by Alricho), Dam of :
HADJI DU PANJSHIR (c, by Dormane) **1 win** & 2 places in Qatar
 Tornade De Faust (f, by Tornado de Syrah) 3 places from 4 starts
 Hassan De Faust (c, by Tornado de Syrah) 3 places in UK
 Hamac (g. by Tornado de Syrah) 6 places in UK

3rd Dam: **ALLEGORIE** (f, by Fawzan) Unraced, Dam of:
 Altyv (f, by Alricho) unraced, Dam of:
PINKIE TUSCADERO (f, by Izentesheshal) **2 wins** & 10 place
ALCAZAR DE TYV (c, by Djelfor) **1 win** & 10 places
ALRITYV (c, by Alricho) **3 wins** & 14 places

No:52

R.S. RAAD (AE)
Grey, Gelding,
26/01/2002

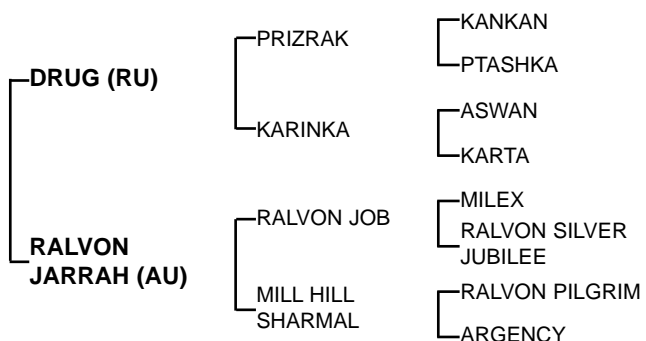

Sire: DRUG (c, by Prizrak) a **Great racehorse, 35(13-9-3)** incl, Russian Derby, the Elite and placed 2nd in great summer Prize, SM Budenny, the Elite Also raced in France and UK, **winner** of couple d'Europe du Cheval Arabe. Sire of **winner**s.

1st Dam: **RALVON JARRAH** (f, by Ralvon Job)

No:53

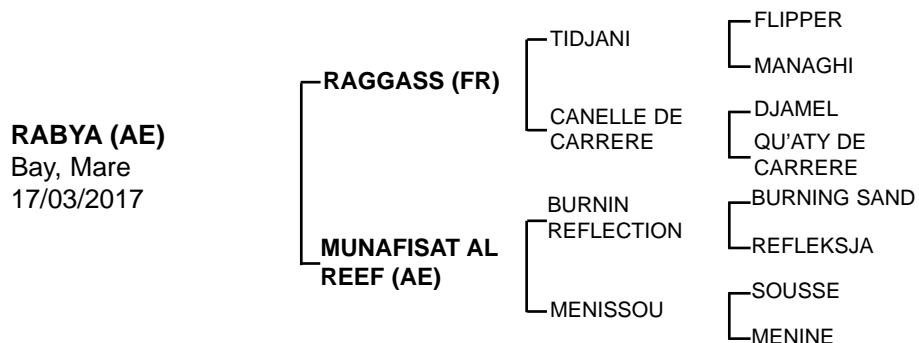

Sire: **RAGGASS** (c, by Tidjani) **4 wins** & 5 places in UAE, incl: 3rd HH The President Cup (**Gr.1**), 3rd Mazrat Al Ruwayyah (**Gr.2**). His sire **TIDJANI** (c, by Flipper) **won 5 races** at 3 years from 5 starts **winning** including La Teste, Prix Kristine, Pompadour, Prix Dahman, Pompadour and Prix Massoud, Pompadour; leading sire of **winners** including **DJANIZID, ELIXIR DE BASTORRE, MASSAMARIE, ALA CROXINOIRE, TAHAAR DE CANDELON, CARLOTTA DU PAON, CATIDJA, MAFATAMA** & among others.

1st Dam: **MUNAFISAT AL REEF** (f, by Burnin Reflection) **1 win** & 3 places, Her sire **BURNIN REFLECTION** (c, by Burning Sand) unplaced from 2 starts in UAE, **Full Brother** to **BIG EASY - 23 wins** & 15 places (incl: **6 Gr. wins** & 9 **Gr** places) from 36 starts in USA & UAE - **\$ 445, 232**. His sire **BURNING SAND** (c, by San Lou Romirz) **6 wins** & 5 places (incl: **2Gr. wins** & 1 **Gr.** place) from 11 starts, Leading sire by a decisive margin 3.75 years in a row. Over **\$3.8m million** in earning, **84% winners, 40% Stakes winners**, TVG Horse Racing Sports announcer commented that **BURNING SAND** was “**The most dominant sire in all horse racing sport, without a doubt**” The announcer went on note that **BURNING SAND** had by far the best percentage of any other horse, incl: Thoroughbred sires **UNUSUAL HEAT, AP INDY & STORM CAT**. Earn money **\$ 24,596**. sire of **many winners**.

2nd Dam: **MENISSOU** (f, by Sousse) unraced, Dam of:
MONAWER (c, by Bibi de Carrere) **4 wins** & 22 places
Nesr Al Reef (c, by Bibi De Carrere) 6 places in UAE.
Ortagon (2017 c, by Mahabb) 2 placed from 5 starts.

3rd Dam: **MENINE** (f, by Manganate) unraced, Dam of:
SOUSOFF (g, by Sousse) **2 wins** & 14 places
MENDRA (f, by Sousse) unraced, Dam of **winners** incl:
MANARK (c, by Mahabb) **4 wins** & 4 places
MESTOR (c, by Mahabb) **3 wins** & 7 places

No:54

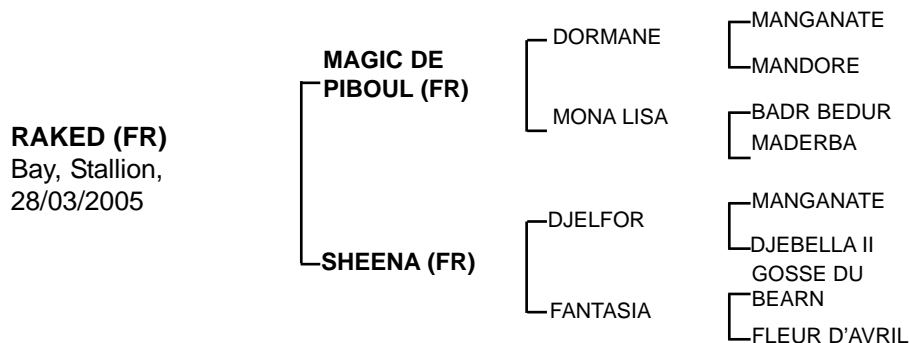

RAKED - 3 wins & 8 places, 2nd Prix Kesberoy (Gr.1) in France, Emirates Championship (Gr.1) in UAE, 3rd The President of The UAE Cup (Gr.1)- UK.

Sire: **MAGIC DE PIBOUL** (c, by Dormane) **6 wins & 5 places**, incl: **1st** Dubai Kahayla Classic (**Gr.1**), The President of The UAE International Challenge Derby (**Gr.1**), Coupe d'Europe Et Des Emirats Arabes Unis (**Gr.1**), 2nd The Dubai International Stakes (**Gr.1**), 4th Prix de L'A.F.A.C (**Gr.1**), 5th La Coupe d'AlAsayl Management (**Gr.1**). **FULL Brother** to **MADOUA DE PIBOUL & Half Brother** to **MASSALLA DE PIBOUL, MORGANE DE PIBOUL, MALIK DE PIBOUL**. Sire of: **UN'ART, AL JANOUB, MAGIK D'OR, LEAULITA, RAKED & many more.**

1st Dam: **SHEENA** (f, by Djelfor) **5 wins & 12 places** in UAE. Dam of:

SHADIYDA (c, by Al Sakbe) **8 wins & 11 places**, incl; Abu Dhabi Championship (**Gr.1**), French Arabian Breeder's Cup (**Gr.1**), Emirates Championship (**Gr.1**), Sh. Khalifa Triple Crown R2 (**Gr.3**).

RAAZIQ (c, by Munjiz) **4 wins & 5 places**, incl; Al Maktoum Challenge R3 (**Gr.1**), 2nd Al Maktoum Challenge R2 (**Gr.1**), Al Maktoum Challenge R1 (**Gr.1**), 3rd Dubai Kahayla Classic (**Gr.1**).

THAKIF (c, by Mahabb) **7 wins & 19 places**, incl: National Day Cup (**Gr.1**), H.H. The President Cup (**Gr.1**), Sh. Zayed Bin Sultan Al Nahyan Cup (**Gr.3**), Al Ruwais (**Gr.3**).

RAKED (c, by Magic De Piboul) **3 wins & 9 places**, incl: 2nd Emirates Championship (**Gr.1**), 3rd The President of the UAE Cup (**Gr.1**).

BIBISHEENA (f, by Bibi De Carrere) **2 wins & 7 places**

RAHEF (c, by Kerbella) 3 places from 4 starts, incl: 2nd Prix Cheri Bibi (**Gr.2**), Prix Tidjani (Gr.3).

SHAMMAR (c, by Bibi De Carrere) **1 win & once 3rd placed.**

Shimaal (f, by Sire D'Albret) 4 places from 5 starts. Dam of:

NAYROUZ (f, by Munjiz) **1 win & 10 places.**

SHUMOOS (f, by Djouras Tu) **1 win & 10 places** in France, Dam of:

AOUN (c, by Mahabb) **5 wins & 13 places**, incl: Prix Tidjani (**Gr.3**), Prix The President of the UAE Cup (**L.PA**).

SUFYAN (c, by Munijiz) **2 wins & 3 places**

HAMMSA (f, by Sarrab) **1 win & 2 places**

AJJAJ (c, by Tahar De Candelon) **5 wins & 15 places**

HAAJEB (c, by Mawood) **3 wins & 17 places**, incl: Al Maktoum Challenge R2 (**Gr.1**), 4th Bani Yas (**Gr.2**).

No:55

R.S RAMAH (AE)
Chestnut, Stallion
31/01/2014

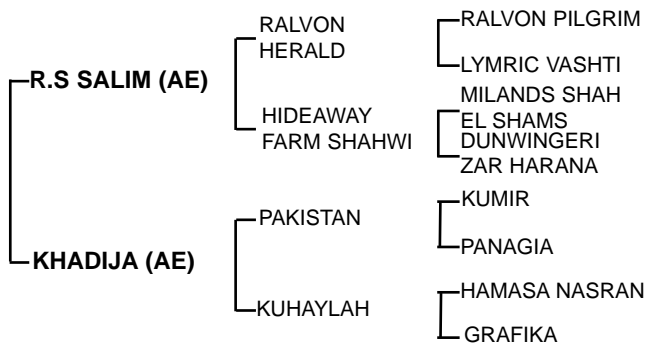

Sire: **R.S SALIM** (c, by Burkan).

1st Dam: **KHADIJA** (f, by Pakistan).

No:56

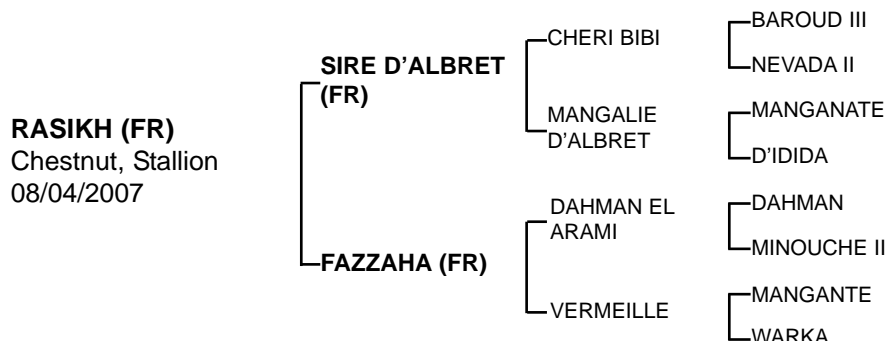

RASIKH - 5 wins & 10 places, 2nd Coupe de France des Chevaux Arabes (Gr.1).

Sire: **SIRE D'ALBRET** (c, by Cheri Bibi) **4 wins** at 4yo & 3 places from 9 starts in France & in UAE. **FULL BROTHER** to **BENGALI D'ALBRET** & **Half Brother** to **AL NASR**. sire of **winners** incl: **IJAD, MURAWIH, DAFFAH, BADDAH** & many more. His sire **CHERI BIBI** (c, by Baroud III) **4 wins** from 4 races at 3 y o, Prix Special - Tarbes, Prix Saint Laurent - Pompadour, Prix Djerba Oua - Biarritz, Prix de Romblat - Pompadour. **Sire of many winners** including: **BENJI, KHAIROUAN, CHERIFIEN, OCTAVIUS, ABITIBI, ZACAN EL BARAKA, BACO DU CASSOU, DIDA CHERIE, BENGALI D'ALBRET, SIRE D'ALBRET, CHERIFA, DJOURIBI, BABELIA, ATUS DE DOMENJOI** & among others.

1st Dam: **FAZZAHA** (f, by Dahman El Arami) Dam of:

DA'AREEN (f, by Bibi De Carrere) **5 wins & 21 places**

GHALIB (c, by Munjiz) **4 wins & 15 places, 1st Prix Cheri Bibi (Gr.2), 2nd Prix Tidjani (Gr.3), 3rd Qatar Total Arabian Trophy (Gr.1).**

NAJMAAH (f, by Sire D'Albret) **1 win & 3 places. 5th Prix de L'Elevage (Gr.2).**

QADER (c, by Munjiz) **5 wins & 3 places**

YARAA (f, by Sarrab) **3 wins & 4 places, 2nd French Arabian Breeders Challenge (Gr.2).**

HADY (c, by Saklawi Jadrane) **1 win & placed from 2 starts. 4th Coupe de France des Chevaux Arabes (Gr.1).**

2nd Dam: **VERMEILLE** (f, by Manganate) 4 places from 8 starts, Dam of:

FANDIM (g, by Bibi De Carrere) **2 wins & 3 places**

Fatenah (Regal De Khan) once 3rd place from 6 starts, Dam of:

BH FATAN (g, by Al Reef) **1 win & 3 places in UAE.**

Shaiyka (f, by Sire D'Albret) unplaced, Dam of:

NARJES (f, by Munjiz) **1 win & 7 places, 5th Prix Razzia III (Gr.3).**

3rd Dam: **WARKA** (f, by Navar) unraced. Dam of:

WAARH (f, by Djamel) **1 win & 2 places**

WAPITIE (f, by Manganate) **4 wins & 7 places. Dam of:**

WALL STREET (c, by Zacan El Baraka) **3 wins & 14 places**

VERT MOUSSE (f, by Djelfor) **2 wins & 5 places**

VERT GALANTE (f, by Dunixi) **5 wins & 14 places. Dam of:**

GHANTI (f, by Abitibi) **1 win & once 2nd placed**

VERDORA (c, by Dormane) **2 wins & 7 places.**

No:57

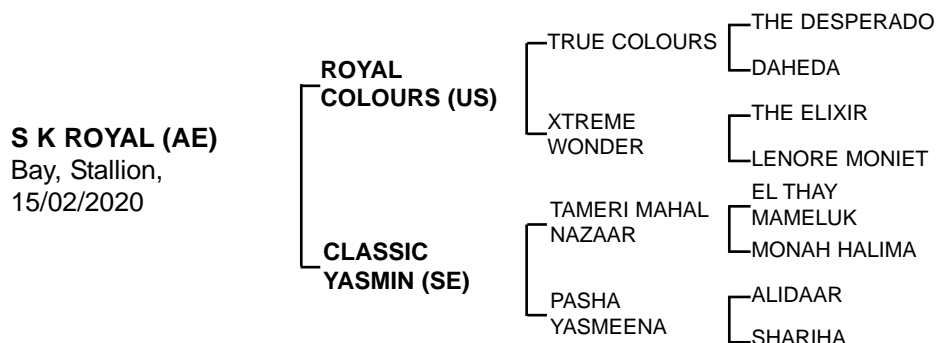

Sire: ROYAL COLOURS (c, by True Colours)

The World Platinum Champion Stallion

2009 Senior Champion Stallion - Dubai International championship

2009 World champion stallion - World Championship

2006 World Champion Colt - World Championship, Paris

2006 Reserve Champion Colt - Aachen, Germany

Sire of many champions incl: D KHATTAF -

Gold Champion - Senior Stallion - Emirates Breeders Championship 2016

Gold Champion - Senior Stallion - Sharjah Festival UAE Bred 2016

Gold Champion - Junior Colts - Sharjah Int'l Festival 2016

D HAYDAR - Gold Champ Colts - Shatjah Straight Egyptian Festival - 2014

PSE RASHEEKAH - Gold Champ - Senior mare- Kuwait Int'l Egyptian - 2015

D MONAF - Gold Champ - Junior Colts - Kuwait Egyptian Event - 2015

PSE RAKHAN - Gold Champ - Egyptian Event Europe - 2013

D MARAKSH - Gold Champ - Bouthieb & Ajman Show 2013

ABHA KAREEM - Silver Champ Senior Male - Rabab Championship Int'l 2015

CS IZAZ ASAYL - Bronze Champion - Porto Sant El'pedia, Italy 2012,

AD MAGIC COLOURS - Bronze Champ Senior Male - National C Show 2013

KHADIJA BY KHALILA - Silver Champ - Kuwait Int'l Egyptian Event 2015

D FAAIQ - Silver Champ - Colts - Sharjah S.E Festival 2014

1st Dam: **CLASSIC YASMIN** (f, by Tameri Mahal Nazaar) Dam of:

G.S. NADA GULFA - 2nd Fillies 1year old - 4th Int'l Straight Egyptian Show 2014.

2nd Dam: **PASHA YASMEENA** (f, by Alidaar), Dam of:

NESYAMON AL BORAQ -

1st Colts 3years old - Concours Regional 2 - 2015.

2nd Colts 1year old - Concours Regional - 2013.

3rd Colts 1year old - National Championship 2013.

NAJIB YASMINAH -

2nd Mares 10years & older - Czech National Championship 2019.

YUSRA AL BORAQ -

2nd Fillies 2 years old - Concours Regional D 2011.

1st Fillies 2 years old - Championat National 2011.

No:58

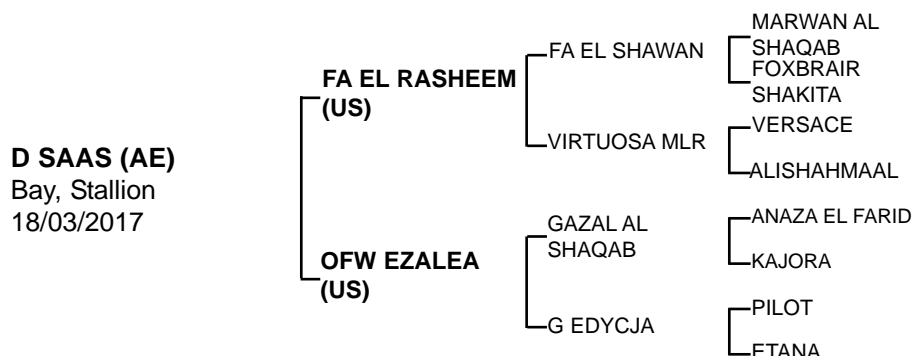

D SAAS - 3rd Colts 2 years - EAHS National Championships 2019

Sire: **FA EL RASHEEM** (c, by FA El Shawan)

GOLD CHAMPION - Junior Male - Arabian Championship Menton 2014

SILVER CHAMPION - Junior Male - World Championship 2014

SILVER CHAMPION - Junior Colts - All Nations Cup 2013

Sire of:

D MUMAYYAZAH -

GOLD CHAMPION - Yearling Filly - Ajman 2017

GOLD CHAMPION - Yearling Filly - Abu Dhabi Int'l Championship - 2017

D SERAJ -

GOLD CHAMPION - Yearling Colt - World Championship 2016

GOLD CHAMPION - Yearling Colt - All Nations Cup 2016

GOLD CHAMPION - Yearling Colts - Arabian Championship Menton 2016

GOLD CHAMPION - Yearling Colt - Dubai Int'l Championship 2016

D MASAH - **GOLD CHAMPION** Filly - Ajman 2017

D JAWAHER - **GOLD CHAMPION** - Yearling Fillies - Vichy Int'l B Show 2016

GOLD CHAMPION - Yearling Fillies - Sharjah Int'l Festival 2016

ROWAIAT AL BUSTAN -

GOLD CHAMPION - Junior Fillies - Emirates Breeders Championship 2015

SHARAF AL SHAHANIA -

GOLD CHAMPION - Junior Colts - Vichy Int'l B Show 2016

MAI AL JASSIMYA -

GOLD CHAMPION - Junior Fillies - World Championship 2016

SG SA'AD -

GOLD CHAMPION - Junior Colts Emirates Breeders Championship 2016

D ARGHAD - **GOLD CHAMPION** - Junior Colts - Elran Cup 2016

D RASHAD - **GOLD CHAMPION** - Junior Colts - 5th Nat Championship Kuwait

D SHALLAL - **Bronze Champion** Yearling Colt & Highest Score - Ajman

1st Dam: **OFW EZALEA** (f, by Gazal Al Shaqab) Dam of:

D MAZAIA (f, by Royal Colours)

Bronze Junior Female Championship - Purosangne Arabi 2014. Dam of:

D MEZYAN -

GOLD Champion yearling Colt - Dubai International Championship 2019

GOLD Champion yearling Colt - Menton Championship 2019

GOLD Champion yearling Colt - Abu Dhabi Int'l Championship 2019

GOLD Champion yearling Colt - UAE National Championship 2019

GOLD Champion yearling Colt - Emirates Breeders Championship 2019.

No:59

SAGIYA (AE)
Chestnut, Mare,
25/01/1998

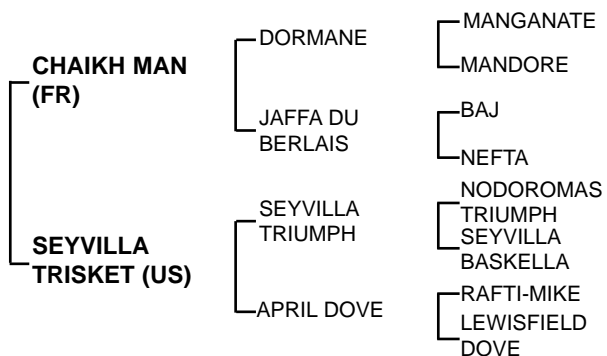

Sire: **CHAIKH MAN** (c, by Dormane) **6 wins** & 6 places from 12 starts in France & UAE. **winning** incl: **1st** Prix Denouste - Toulouse (1600 mtr), Prix Gosse du Bearn - Agen le Passage (2200mtr), Criterium bes Poulains Arabes - Tarbes (2000mtr), In France he was rated 2nd equal as a 3 year old & One of the first French Stallion to be used in UAE. He represents some of the best racing blood of France, Sire of **winners** incl: **MOUTAWAJ, ADEEM, MASH HOOR, HOUBOUB, MUWASELL, AL NAB'A, ANSHOUDAT FARAH, BILLAMUNAZZE, AF SALETAH** & among others.

1st Dam: **SEYVILLA TRISKET** (f, by Seyvilla Triumph) 2 places from 3 starts.

No:60

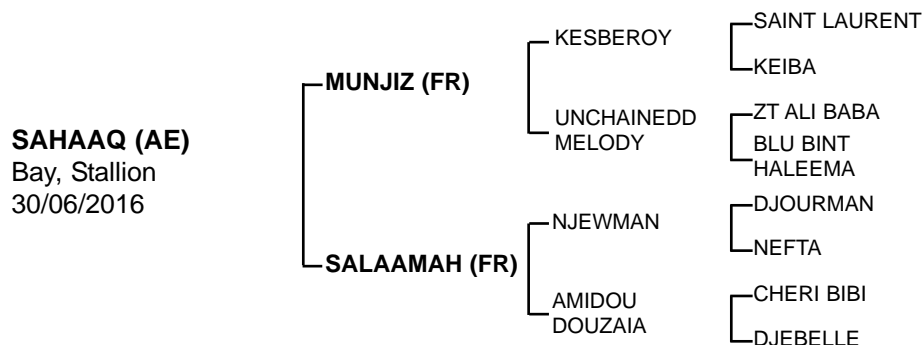

Sire: **MUNJIZ** (c, by Kesberoy) **1 win & 4 places** from 6 starts. **winner** of: Prix du President des Emirats Arabes Unis - Challenge Derby (**Gr.1**), 2nd Prix de Carthage (**Gr.2**), 3rd Prix du Haras de Gelos. **Half brother** to **MIZZNA, MIJDADD**. Sire of **winners** incl: **JOSCO DU CAUROU, GHALIB, SAHLAMBO, MUNZADE, MYRA DE MONLAU, AAKIF, AL MAMUN MONLAU, AWAM, ELYAAH, AL BASHTOON, MISTER DU LOUP, MELK, FANTASY MISS, LADY WISH, MISS FANTASIA, MASCATE, GHADEER, KARLOS DU CAYROU, ZAKHO, THABIT, BANDAR, NAJAH, YATHRIB, MUNOWRA, AUSTRALYA, SOMOUD, ESKANDAR, BASEEL, DUZAR, MUNZADE, CANDAHAR, MUSHARAF & many more.**

1st Dam: **SALAAMAH** (f, by Njewman) **3 wins & 3 places**, 1st The Emirates Equestrian Federation Int'l Stakes (**Gr.2**), 2nd Prix Nevada III (**Gr.3**). Dam of: **SAAROOKH** (c, by Munjiz) **2 wins & 7 places** in UAE.

2nd Dam: **AMIDOU DOUZAIA** (f, by Cheri Bibi) **6 wins & 5 places**. Dam of:

MESSINE DE SINUHE (c, by Njewman) **4 wins & 10 places**

DAHWA (f, by Tidjani) **2 wins & 10 places**. Dam of:

THABIT (c, by Munjiz) **4 wins & 8 places**

BANDAR (c, by Munjiz) **3 wins & 7 places**

NAJAH (f, by Munjiz) **2 wins & 2 places**

HABOOB (f, by Akbar) **1 win & 2 places**. Dam of:

SHAHM (c, by Mahabb) **3 wins & 2 places**

MARZOOQ (c, by Bibi De Carrere) **2 wins & 2 places**

YATHRIB (f, by Munjiz) **1 win & 5 places**

AMJAD (f, by Akbar) **1 win & 3 places**

ARYAAN (f, by Kesberoy) **1 win & 4 places**. Dam of:

LAHAHQ (c, by Dormane) **3 wins & 2 places**

NASEEM (c, by Mahabb) **6 wins & 8 places**

ALIAA (f, by Djelfor) **3 wins & 2 places** in UAE. Dam of:

ABHAAR (c, by Al Nasr) **7 wins & 5 places**

FATAT AL ARAB (f, by Al Nasr) **3 wins & 2 places**

ASYAD (f, by TH Richie) **1 win & 9 places**.

MUSTAJEEB (g, by Calin Du Loup) **1 win & 2 places**.

ASSILA (f, by Dormane) **1 win & 3 places** from 5 starts in UAE. Dam of:

AASAL AL REEF (f, by Bibi De Carrere) **1 win & 9 places**.

MOWAFKA (f, by Tidjani) unraced, Dam of:

ELAF (f, by Rabbah De Carrere) **1 win & 4th Qatar Arabian Trophy (Gr.1)**.

BAYAN (f, by Munjiz) **3 wins & 4 places**. **1st Hatta International Stakes (Gr.1)**, Qatar Prix de L'Elevage (**Gr.2**), 2nd Qatar Arabian Trophy (**Gr.1**).

No:61

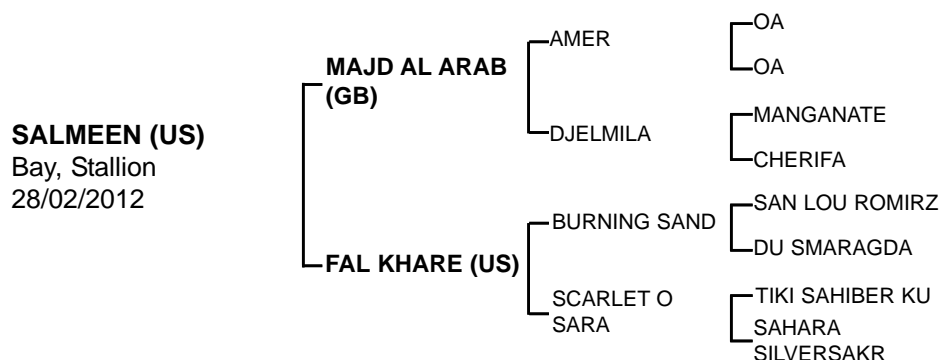

SALMEEN - 1 win & 8 places in USA & in UAE. Official Rating: 35

Sire: MAJD AL ARAB (c, by Amer) **10 wins** incl: **5 Gr.1 races** & 4 places from 16 starts in Middle East & Europe. **winning** incl: **1st** HH The Emir's Sword (**Gr.1**), **1st** Qatar International Trophy (**Gr.1**), **1st** Coupe d'Europe des Chevaux Arabes (**Gr.1**). Sire of **many winners** incl: **MUNTASAR - 6 wins** & 9 places, **RB CHAMPAGNE TATSTE - 3 wins** & 9 places, **TM THUNDER STRUCK - 4 wins** & 10 places, **MAYASA - 2 wins** & 5 places, **MAJD AL URAIQ - 9 wins** & 13 places, **ABHAR - 4 wins** & 13 places, **MAJIDD - Multiple winner** in Qatar, **SAMJIDA - 2 wins** & 5 places & many others.

1st Dam: FAL KHARE (f, by Burning Sand) unplaced from 1 start. Her sire **BURNING SAND** (c, by San Lou Romirz), **6 wins** & 5 places incl: **2 Gr. wins** & **1 Gr. place** from 11 starts - \$ **24,596** - Sire of **many winners** incl: **BIG EASY** (c, by Burning Sand) **23 wins** & 15 places (incl: **6 Gr. wins** & **9 Gr. places**) from 36 starts in USA & UAE - \$ **445,232**. **LINE DANCER - 24 wins** & 5 places (incl: **17 Gr. wins** & **4 Gr. places**) - \$ **423,061**, **AIM SOUTH - 16 wins** & 37 places (incl: **7 Gr. wins** & **10 Gr. places**) - \$ **383,468**, **CATH - 10 wins** & 5 places (incl: **9 Gr. wins** & **3 Gr. places**) - \$ **226,620**, **ABRA CAADABRA - 9 wins** & 34 places (incl: **3 Gr. wins** & **6 Gr. places**) - \$ **133,510**, **QUICK SAND PW - 7 wins** & 13 places (incl: **3 Gr. wins** & **5 Gr. places**) - \$ **117,049**, **SAND WITCHH - 4 Gr. wins** including from **5 wins** from 5 starts - \$ **63,360**, **REDA - 4 wins** & 8 places (2017 Dubai Kahayla Classic (**Gr.1**)), **MAISOOR - 9 wins** & once 4th place from 10 starts, **PADDY'S DAY - 22 wins** & 10 places, **RB KINDLE**, **CODYS SURPRISE**, **HIGHH SHINE**, **UPTOWN SANDY GIRL**, **RB HOT DATE**, **SAND VICTOR**, **EXTRA HOPE**, **LADY DAWN AA**, **SANDICHEEKS**, **IVORY SHORES**, **RAINEING SAND** & many more.

2nd Dam: SCARLET O SARA (f, by Tiki Sahiber Ku) unraced, Dam of :
MW SCARLET LADY (f, by K A Czubuthan) **Multiple Stake winner**, **6 wins** & 21 places.
TARA O SARA (f, by TQ Wroclaw) **Stake winner 2-7(2-2-1)1-0**
BURNING SPEED MKP (g, by Burning Sand) **2 wins** & 27 places
EXCHANGE (c, by K A Czubuthan) **1 win** & 5 places
TM BURNING BRIDGES (c, by Burning Sand) **3 wins** & 19 places, 3rd Crow Valley Ranch Classic Stakes (**Gr.3**)
TM MADDAMEE (f, by Burning Sand) **5 wins** & 49 places.

No:62

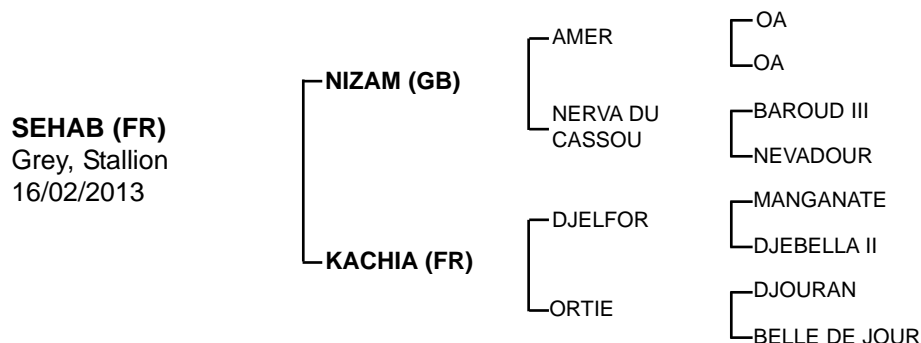

SEHAB - 3 wins & 13 places. OFFICIAL RATING: 101.

Sire: NIZAM (c, by Amer) **15 wins & 8 places. winning** incl: **1st** HH Emir's Sword (Gr.1), HH The President Cup (Gr.1), Qatar Derby Cup (Gr.2), Zabeel Int'l Stakes (Gr.1), Deputy PM Sword (Gr.1). Sire of many **winners** incl: **TABARAK, AL URAIQ, AL MOUHANNAD, FARH, DJARNIZAM, MAAMORA, NERBAH, SAHABBA, LAHEEB, AL SHAHANIA, MAN OF DREAMS** & many more.

1st Dam: **KACHIA** (f, by Djelfor), Raced in Qatar and UK with race record of **7(1-2-2)**, Dam of **winners** incl;

MUGADIR (c, by Amer) 17 wins & 3 places from 20 starts,

MURHIB (c, by Amer) **won 11** races in Qatar and The Netherlands, **1st** Qatar National Day Trophy (Gr.1), Qatar International Derby (Gr.2), President of the UAE Cup-Hydra (Gr.3).

DAMIS (c, by Amer) **11 wins & 16 places, 1st** HH The Heir Apparent Trophy (Gr.1), The President of The UAE Cup (Gr.1), International IFAHR Trophy (Gr.2).

LAMYAH (f, by Amer) **winner** in Qatar.

BAHJAH (f, by Majd Al Arab) **1 win & 4 places** from 5 starts.

KEILAN (c, by Amer) **22 wins & 15 places** in Qatar.

2nd Dam: **ORTIE** (f, by Djouran) **1 win & 12 places** from 13 starts. Dam of **winners**:

ABU ALABYAD (c, by Akbar) **6 wins & 22 places, 1st** HH The President Cup (Gr.1), Prix Kesberoy - Al Rayyan Cup (Gr.1).

ORDINATION (c, by Dormane) **14 wins & 54 places**

ORDAINED (c, by Dormane) **19 wins & 47 places**

DORAN (c, by Dormane) **2/7 (5-1-0) 4-1, \$97,093, 1st** Jewels of the East Diamond Derby (Gr.1), Ales Courtlis Juvenile Stakes (Gr.2), 2nd Drinkers of the Wind Derby (Gr.1).

AMMANTE (f, by Dormane) **3 wins & 5 places**, Dam of:

INTRYGE (c, by Calin du Loup) **2 wins & 21 place**

BRULANTE (f, by Burning Sand) **3 wins & 6 places**

ZERALDA JOSNIERE (f, by Djelfor) **4 wins & 14 places** in USA, Dam of:

RICHLY BLESSED (f, by TH Richie) **2 wins & 10 places**

COU DE TA (f, by Wiking) **3 wins & 18 places**. Dam of:

RASTA ROCKET (c, by Kaolino) **1 win & 3rd place** from 2 starts

RUBY EARRINGS (f, by Rubis de Carrere) **2 wins & 18 places** in USA.

MEDIATIK (c, by Air De Cour) **1 win & 14 places - Sire**

No:63

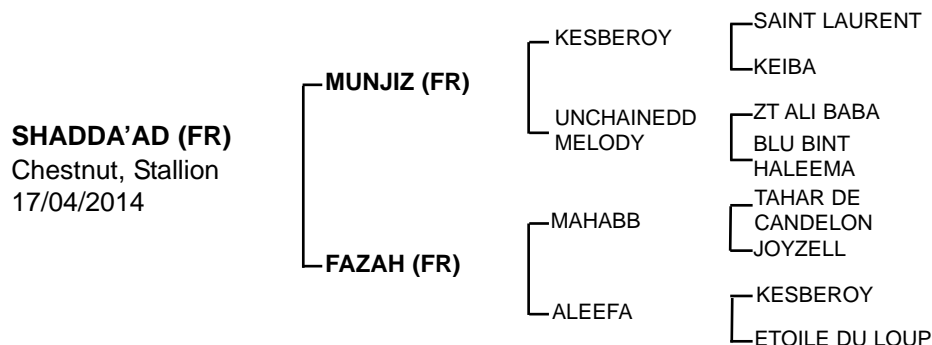

SHADDA'AD - 2 wins & 8 places in France & in UAE, 2nd Al Ain Mile (Gr.3), Grand Prix de S.A.R. Le Prince Heritier Moulay El Hassan (Gr.3). Official Rating:100

Sire: **MUNJIZ** (c, by Kesberoy) **1 win & 4 places** from 6 starts. **winner** of: Prix du President des Emirats Arabes Unis - Challenge Derby (Gr.1), 2nd Prix de Carthage (Gr.2), 3rd Prix du Haras de Gelos. **Half brother** to **MIZZNA, MIJDADD**. Sire of **winner**s incl: **JOSCO DU CAUROU, GHALIB, SAHLAMBO, MUNZADE, MYRA DE MONLAU, AAKIF, AL MAMUN MONLAU, AWAM, ELYAAH, AL BASHTOON, MISTER DU LOUP, MELK, FANTASY MISS, LADY WISH, MISS FANTASIA, MASCATE, GHAEER, KARLOS DU CAYROU, ZAKHO, THABIT, BANDAR, NAJAH, YATHRIB, MUNOWRA, AUSTRALYA, SOMOUD, ESKANDAR, BASEEL, DUZAR, MUNZADE, CANDAHAR, MUSHARAF & many more.**

1st Dam: **FAZAH** (f, by Mahabb) **3 wins & 3 places** from 6 starts, **1st** Prix Nevada II (Gr.2), Prix Razzia III (Gr.3), 2nd Qatar Arabian Trophy (Gr.1), 3rd Qatar Prix de L'Eleveage (Gr.2), 4th Qatar Total Arabian Trophy (Gr.1).

2nd Dam: **ALEEFA** (f, by Kesberoy) 6 places from 6 starts. Dam of:
BALQEES (f, by Mahabb) **5 wins & 7 places**, **1st** Criterium Des Pouliches (Gr.2), Prix Nevadour (Gr.3), 3rd French Arabian Breeders Challenge Classic (Gr.1), Prix Nefta (Gr.3).
NAZIQ (f, by Mahabb) **4 wins & 5 places**, **1st** Qatar Total Arabian trophy (Gr.1), Criterium des Pouliches (Gr.2), 2nd Prix nefta (Gr.2), Prix Nevadour (Gr.3).
LORAA (f, by Mawood) **7 wins & 9 places**, **1st** HH The President Cup (Gr.1), Qatar Total Arabian Trophy (Gr.1)(X2), Qatar Prix de L'Eleveage (Gr.2), Criterium des Pouliches (Gr.2), 2nd Hatta Int'l Stakes (Gr.1).

3rd Dam: **ETOILE DU LOUP** (f, by Blaise) unraced, Dam of:
LAHIB (c, by Kairouan de Jos) **5 wins & 7 places**
 Eshraq (f, by Djelfor) unraced, Dam of:
DIG DAGON (c, by Bibi De Carrere) **3 wins & 17 places.**
WADYA (f, by Akbar) **5 wins & 7 places** in France & in UAE. incl: 5th Emirates Championship (Gr.1). Dam of:
SOMOUD (c, by Munjiz) **5 wins & 11 places** in France & in UAE. incl: Emirates Championship (Gr.1), Al Ain Mile (Gr.3).
Shahira (f, by Mahabb) unplaced from 4 starts. Dam of:
SHADDAD AL WATHBA (c, by Bibi De Carrere) **1 win** from 3 starts.
ESKANDAR (c, by Munjiz) **1 win & 1 place.**

No:64

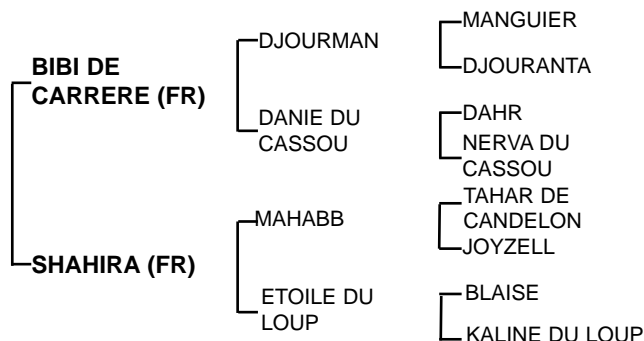
SHADDAD AL WATHBA (AE)Grey, Stallion
09/12/2014**SHADDAD AL WATHBA - 1 win from 3 starts, Official Rating: 60**

Sire:**BIBI DE CARRERE** (c, by Djourman) **8 wins** and 6 places from 17 starts at 3- 5yo in France & UAE, Sire of **many winners** incl: **RABBAH DE CARRERE - 5 wins & 5 places**, **DYNAMITE - 10 wins & 23 places** - The First Local bred in the History of Arabian Racing to winner of HH The President Cup (**Gr.1**), **NAHEE - 4 wins & 4 places**, **CARAT - 4 wins & 8 places**, **SHA'RED - 2 wins & 5 places**, **MARZOOQ - 2 wins & 1 place**, **RS KERIM - 6 wins & 3 places**, **SAKEN - 8 wins & 6 places** & among others.

1st Dam: **SHAHIRA** (f, by Mahabb) unplaced from 4 starts. Dam of:
SHADDAD AL WATHBA (c, by Bibi De Carrere) **Subject Horse**.
Haleem Al Wathba (c, by Munjiz)

2nd Dam: **ETOILE DU LOUP** (f, by Blaise) unplaced, Dam of:

LAHIB (c, by Kairouan de Jos) **5 wins & 7 places**

ESKANDAR (c, by Munjiz) **1 win & 1 place**

MUBASHER (c, by Bibi de Carrere) **1 win & 5 places**

WAASEL (c, by Kerbella) **1 win & 6 places**

HARB (g, by Kerbella) **1 win & 5 places**

Aleefa (f, by Kesberoy) 6 places from 6 starts. Dam of:

NAZIQ (f, by Mahabb) **2 wins & 3 places**

LORAA (f, by Mawood) **6 wins & 7 places**

FAZAH (f, by Mahabb) **3 wins & 3 places**.

Eshraq (f, by Djelfor) unraced, Dam of:

DIG DAGON (c, by Bibi De Carrere) **3 wins & 17 places**.

WADYA (f, by Akbar) **5 wins & 7 places** in France & in UAE. incl: 5th Emirates Championship (**Gr.1**). Dam of:

SOMOUD (c, by Munjiz) **5 wins & 11 places** in France & in UAE. incl:

Emirates Championship (**Gr.1**), Al Ain Mile (**Gr.3**).

3rd Dam: **KALINE DU LOUP** (f, by Djouras Tu) 4 places from 5 starts. Dam of:

CALIN DE LOUVE (c, by Djelfor) **8 wins** from 8 starts. incl: Darley Stud Arabian Cup Classic (**Gr.1**), AJC Derby (**Gr.1**), Drinkers of the Wind Futurity (**Gr.2**), California Futurity (**Gr.3**). Earned Prize money more than **\$123,000 USD - Sire**.

KAL BARQ (c, by Dormane) **9 wins & 10 places** in UAE.

KHATTAFF (c, by Dormane) **1 win & 5 places**.

RAHEQ (g, by Kerbella) **1 win & 13 places**.

No:65

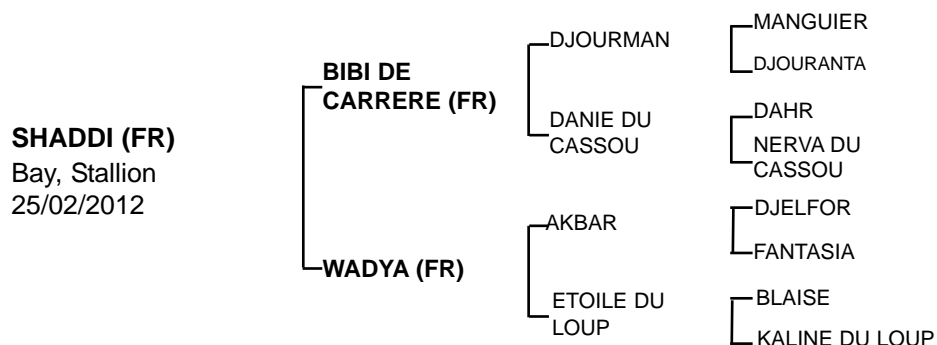

Sire: **BIBI DE CARRERE** (c, by Djourman) **8 wins** and 6 places from 17 starts at 3- 5yo in France & UAE, Sire of **many winners** incl: **RABBAH DE CARRERE - 5 wins & 5 places**, **DYNAMITE - 10 wins & 23 places** - The First Local bred in the History of Arabian Racing to winner of HH The President Cup (**Gr.1**), **NAHEE - 4 wins & 4 places**, **CARAT - 4 wins & 8 places**, **SHA'RED - 2 wins & 5 places**, **MARZOOQ - 2 wins & 1 place**, **RS KERIM - 6 wins & 3 places**, **SAKEN - 8 wins & 6 places & among others.**

1st Dam: **WADYA** (f, by Akbar) **5 wins & 7 places** in France & in UAE. incl: 5th Emirates Championship (**Gr.1**). Dam of:

SOMOUD (c, by Munjiz) **5 wins & 11 places** in France & in UAE. incl: Emirates Championship (**Gr.1**), Al Ain Mile (**Gr.3**), 2nd Prix Cheri Bibi (**Gr.3**), 3rd Prix Tidjani (**Gr.3**), 4th Al Rayyan Cup (prix Kesberoy) (**Gr.1**).
Anmaar (2015 f, by Munjiz) 1 placed from 3 starts.
SHADDI (c, by Bibi De Carrere) **Subject Horse.**

2nd Dam: **ETOILE DU LOUP** (f, by Blaise) unraced, Dam of:

LAHIB (c, by Kairouan de Jos) **5 wins & 7 places**
ESKANDAR (c, by Munjiz) **1 win & 1 place**
MUBASHER (c, by Bibi de Carrere) **1 win & 5 places**
WAASEL (c, by Kerbella) **1 win & 6 places**
HARB (g, by Kerbella) **1 win & 5 places**
Aleefa (f, by Kesberoy) 6 places from 6 starts. Dam of:
NAZIQ (f, by Mahabb) **2 wins & 3 places**
LORAA (f, by Mawood) **6 wins & 7 places**
FAZAH (f, by Mahabb) **3 wins & 3 places.**

Eshraq (f, by Djelfor) unraced, Dam of:

DIG DAGON (c, by Bibi De Carrere) **3 wins & 17 places.**

Shahira (f, by Mahabb) unplaced from 4 starts. Dam of:

SHADDAD AL WATHBA (c, by Bibi De Carrere) **1 win** from 3 starts.

3rd Dam: **KALINE DU LOUP** (f, by Djouras Tu) 4 places from 5 starts. Dam of:

CALIN DE LOUVE (c, by Djelfor) **8 wins** from 8 starts. incl: Darley Stud Arabian Cup Classic (**Gr.1**), AJC Derby (**Gr.1**), Drinkers of the Wind Futurity (**Gr.2**), California Futurity (**Gr.3**). Earned Prize money more than **\$123,000 USD - Sire.**
KAL BARQ (c, by Dormane) **9 wins & 10 places** in UAE.
KHATTAFF (c, by Dormane) 1 win & 5 places.
RAHEQ (g, by Kerbella) 1 win & 13 places.

No:66

SHAMAN (AE)
Bay, Stallion
15/03/2015

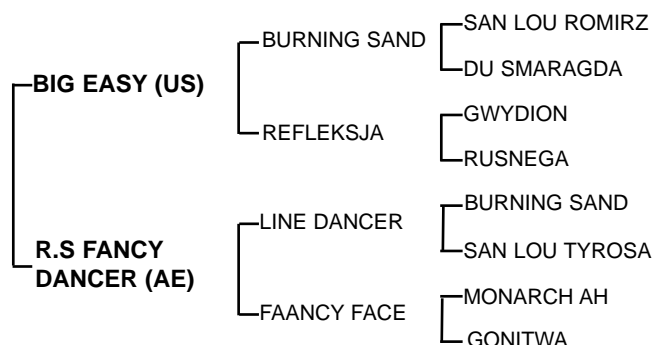

Sire: **BIG EASY** (c, by Burning Sand) **23 wins** & 15 places (incl: **6 Gr. wins** & **9 Gr.** places) from 36 starts in USA & UAE - \$ **445,232**. **winning** incl: **1st** National Day Cup Sponsored by ADNEC (**Gr.1**), **1st** Liwa Oasis sponsored by Al Reef Stable (**Gr.1**), **1st** Al Ruwais (**Gr.3**)(**X2**), **1st** Bani Yas Shadwell Farm Stakes (**Gr.2**), **2nd** Al Rostamani Group Bani Yas (**Gr.2**), **2nd** Ruwais (**Gr.3**), **2nd** Al Jabr Bani Yas (**Gr.2**), **2nd** ALEC Courtelis Juvenile Stakes (**Gr.3**). Sire of **many winners** incl: **BURNING FIRESTAR: 6 wins** & 16 places from 24 starts in USA - \$ **102,612**. **ES AJEEB: 4 wins** from 7 starts, **1st** Bani Yas (**Gr.2**) in UAE, **LATIFA PRINCESS: 5 wins** & 2 places, **ES FATEK: 3 wins** & 5 places in UAE, **ES MAYDAN: 3 wins** & 17 places in UAE, **ES TANGO: 3 wins** & once **2nd** place in UAE, **ES ALMAS: 2 wins** & 2 places, **AL HADAF: 1 win** & 4 places in UAE, **KHOUROS CS: 1 win** & 12 places in USA, **AL MOBHER: 1 win** & 9 places.

1st Dam: **RS FANCY DANCER** (f, by Line Dancer) **1 win** & 5 places from 9 starts, **Full Sister** to **BUSH HOG**. Her sire **LINE DANCER** (c, by Burning Sand) **4/30 (24-5-0)17-4 \$423,061** USA & UAE, he is one of the best known & oldest sons of **Burning Sand**, leading sire of Arabian racehorses in USA since 2006, **LINE DANCER** was an amazing runner with heart to spare. He spent most of his career in the United States, **winning a 17 Stakes Races** (including **multiple Grade 1 stakes**) & **5 Darley Champion**. He **earned** more than \$ **420,000** incl: **2nd** place finish in the prestigious **Kahayla Classic** in Dubai with very little prep. **LINE DANCER** sire of **many winners** & **Stakes winners** incl: **2007 Darley Champion DIXIE DANCE, DANCERS FIRST LUV, BUSH HOG, MOUNTAIN FRESH, LELY ROTERA, SIZEDOESNTMATTER, SOLE DANCER, LE GUSTA BAILAR, VICTORIAS ZELL, AIREAGLE, DARE TO DANCE** & others.

2nd Dam: **FAANCY FACE** (f, by Monarch AH) **1 win** & 4 places from 6 starts in USA, Dam of **winners** incl:

BUSH HOG (c, by Line Dancer) **9 wins** & 23 places

SAND SPIRIT (f, by Burning Sand) **4 wins** & 17 places

Her sire **MONARCH AH** (c, by Wiking) **19 wins** & 4 places (incl: **14Gr wins** & **3Gr** places) **winning** incl: **1st** A.R.A.M. Arabian Cup, **1 st** California Arabian Cup Sprint (**G2**), **1st** AJC Armand Hummer Classic Handicap (**G1**), **1st** AJC Cre Run Handicap(**G3**), **1st** AJC DERBY (**G1**), **2nd** Armand Hammer Classic Handicap (**G1**) **2nd** Florida Arabian Cup Stakes (**G2**), Sire of **Many winners**.

No:67

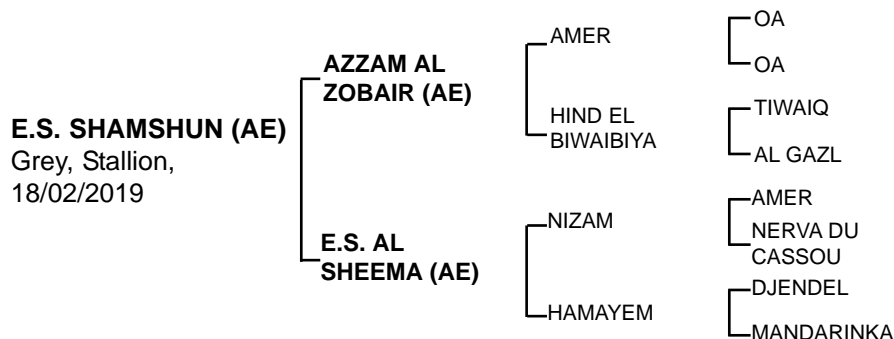

Sire: **AZZAM AL ZOB AIR** (c, by Amer) unplaced from 1 start. Her sire **AMER** (c, by Wafi), **5 wins** from 7 starts in UK. Outstanding sire of **winning race horses Sire of 107 winners** of 432 races including **49 Group 1** races around the world. **AL ANOOD -18 wins** (incl: **6 Gr.1** races), **MUTABAHI - 11 wins** (incl: **4 Gr.1**), **DAHESS - 27 wins** (incl: **13 Gr.1** races), **NIZAM - 15 wins** (incl: **4 Gr.1** races), **AL DAHMA - 22 wins** (incl: **15 Gr.1** races), **MUGADIR - 17 wins**, **MAJD AL ARAB - 10 wins** (incl: **5 Gr.1** races), **MUNEEF - 6 wins** (incl: **1 Gr.1** races), **GENERAL - 5 wins** (incl: **1 Gr.1** races), **AL ANQA - 3 wins**, **DAMIS - 2 wins**, **MURHIB - 10 wins** incl: **Gr.2 & Gr.3 winners**, **MALEEHAH - 16 wins** incl: French **1Gr. win**, **OMAIER - 3 wins**, **RAQIYAH - 5 wins** (incl: **Gr.1** races), **TAMEEMAH - 5 wins**, **AL ZUBARAH - 18 wins**, **DARRAB - 8 wins**, **MALIKA AL MAIDA - 6 wins**, **ZREIG - 4 wins**.

1st Dam: **ES AL SHEEMA** (f, by **NIZAM** (c, by Amer) **15 wins** & 8 places. **winning** incl: **1st** HH Emir's Sword (**Gr.1**) (2400 m) Doha - 2005, HH The President Cup (**Gr.1**) (2200 m) Abu Dhabi - 2004, Qatar Derby Cup (**Gr.2**) (2000 m) Doha - 2002, Zabeel Int'l Stakes (**Gr.1**) (1200 m) Newbury - 2004, Deputy PM Sword (**Gr.1**) (1600 m) Doha - 2003. Sire of many **winners** incl: **TABARAK - Group 1 winner**, **DJARNIZAM**, **MAAMORA**, **AL MOUHANNAD**, **FARH**, **NERBAH**, **SAHABBA**, **HAJRES TUN**, **FAROOQ** & many more).

2nd Dam: **HAMAYEM** (f, by **DJENDEL** (c, by Manganate) **5 wins** & 1 place from 7 starts. **winning** incl: **1st** Prix des Stables (1600 m), Pure Arabian Class (1600 m) (**twice**), HH The Emir's Sword (2000 m), Pure Arabian Race (2400 m), 2nd HH The Emir's Sword. sire of many **winners** incl: **ARA DECIEL** - Best Pure Arabian Horse of 1999 - 2000 Racing Season, **winner** of the 2000 **HH Emir's Sword**. **SAYF** - Best Local Bred Pure Arabian Horse in 1997 - 1999 Racing Season in Qatar, **DJENDEL DAHL** - Best Local Bred Pure Arabian Horse in 1999 - 2000 Racing Season in Qatar, **BARARI** - Top Sprinter & many more).

3rd Dam: **MANDARINKA** (f, by Neftalin) **1 win** & 6 places, **Half Sister** to **BEGONIA** (c, by Moment) **1 win** & 2 places, **MEDIANKA** (f, by Nabeg) **1 win** & 3 places.

No:68

M.O SHOCK (AE)
Chestnut, Stallion
10/05/2011

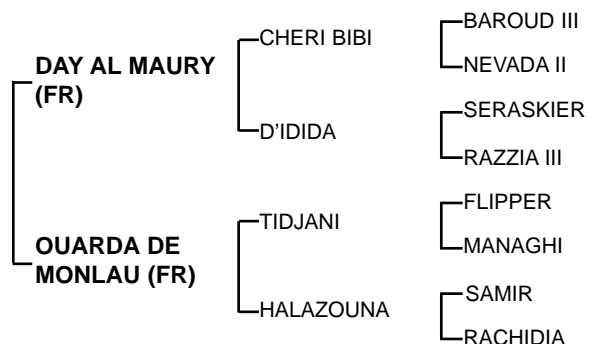

Sire: **DAY AL MAURY** (c, by Cheri Bibi) **2 wins** & 3 places in UAE. **Full Brother** to **DIDA CHERIE** - **11 wins** & 24 places, **MALIKA D'ALBRET** - **4 wins** & 12 places. **Half Brother** to **DON DU CIEL AL MAURY** (c, by Dormane) 2 wins & 7 places. His sire **CHERI BIBI** (c, by Baroud III) **4 wins** from 4 races at 3 y o, Prix Special - Tarbes, Prix Saint Laurent - Pompadour, Prix Djerba Oua - Biarritz, Prix de Romblat - Pompadour. **Sire of many winners** including: **BENJI, KHAIROUAN, CHERIFIEN, OCTAVIUS, ABITIBI, ZACAN EL BARAKA, BACO DU CASSOU, BENGALI D'ALBRET, SIRE D'ALBRET, CHERIFA, DIDA CHERIE, DJOURIBI, BABELIA, ATUS DE DOMENJOI** & among others.

1st Dam: **OUARDA DE MONLAU** (f, by **TIDJANI** (c, by Flipper) **won 5 races** at 3 years from 5 starts **winning** including La Teste, Prix Kristine, Pompadour, Prix Dahman, Pompadour and Prix Massoud, Pompadour; leading sire of **winners** including **DJANIZID, ELIXIR DE BASTORRE, MASSAMARIE, TAHAR DE CANDELON, CARLOTTA DU PAON, CATIDJA, ALA CROXINOIRE, MAFATAMA** & among others.)

2nd Dam: **HALAZOUNA** (f, by Samir) unraced, Her sire **SAMIR** - 30 wins & 7 places Top Tunisian Stallion. Dam of **winner** incl:
RACHIDIA (f, by Dormane) **5 wins** & 9 places from 20 starts in UAE

3rd Dam: **RACHIDIA** (f, by Dynamite III) Dam of:
Fahs (f, by Samir) Dam of:
Fayhsir (f, by Tayssir) unraced, Dam of:
DJEBEL DE FILAN (c, by Djamel) **6 wins** & 14 places
Mamlakah (f, by Dayjur). Dam of:
BLUE DIAMOND (c, by Shadyda) **1 win** & 4 places.
Her sire **DYNAMITE III** - **Top Tunisian Stallion**, sire of:
HALIM (out of Saboua) **31 wins** from 31 starts,
DAYJUR (out of Ismaouni) **13 wins** & 36 places,
BERREZIG (out of Maharzia) **2 wins** & 9 places.

No: **69****SHOOTING SPIRIT
(IRE)**Chestnut, Stallion
24/02/2017**LOPE DE VEGA
(IRE)**

SHAMARDAL [

LADY VETTORI [

**WHITE BULLET
(GB)**EXCEED AND
EXCEL [

CHILI DIP [

SHOOTING SPIRIT - 3 places from 4 starts. **Official Rating: 70.**

Sire : **LOPE DE VEGA** (c, by Shamardal) **4 wins** & 3 places, **1st** Poule d'Essai des Poulains-French Two thousand Guineas (**Gr.1**), Prix du Jockey Club - French Derby (**Gr.1**), 3rd Prix de Fontainebleau (**Gr.3**), 4th Prix Jean Luc Lagardere-Grand Criterium (Gr.1). Sire of **LIBERAL, AMIKO CHOW, JULIE BIRD, KALIFORNIA QUEEN, VOLDOLOBO, AUNT PEARL, NEWSPAPEROFRECORD, LOPE Y FERNANDEZ, CAPITAL STRUCTURE, EDITOR AT LARGE, CADILLAC, NOOR SAHARA, ASSIDUOUSLY, PARISH POET, DEEP THINKER** & many more.

1st Dam: **WHITE BULLET** (f, by Exceed and Excel) **1 win** & 3 places from 4 starts.

Her sire **EXCEED AND EXCEL** (c, by Danehill) **7 wins** & once 2nd place from 12 starts. **winning** incl: Seppelt Wines Newmarket Handicap (**Gr.1**), Royal Sovereign Stakex (**Gr.2**), Dubai Racing Club Cup (**Gr.1**), Rom Consul Stakes (**Gr.3**), Todman Stakes (**Gr.2**), 2nd Black Opal Stakes (**Gr.3**), Australia's Champion Stallion, Sire of 136 stakes performers (**36 Group Winner, 45 Listed Winner**) incl: **AMBER SKY, OUT STRIP, EARTHQUAKE, EXCELEBRATION, GUELPH, HELMET, MARGOT DID, OVER REACH, REWARD FOR EFFORT, BEST TERMS, FULBRIGHT, HEAVE METAL, INFAMOUS ANGEL, KUROSHIO** & among others

THOROUGHBRED

No:70

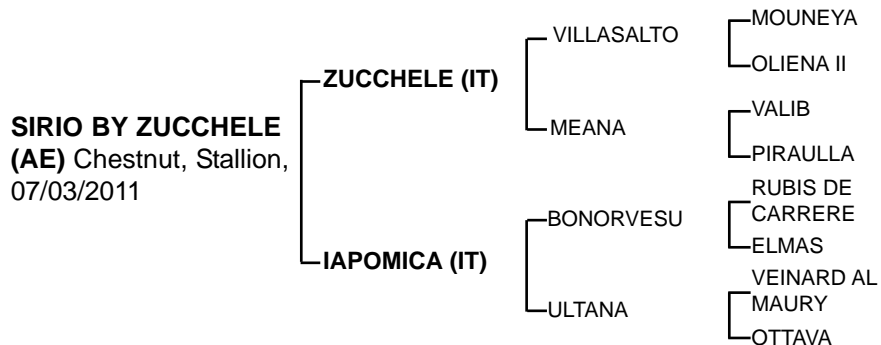

SIRIO BY ZUCCHELE - 1 win & once 3rd placed from 2 strats.

Sire: **ZUCCHELE** (c, by Villasalto) 2 places from 5 starts. Sire of:
TORNADO BY ZUCCHELE - 5 wins & 3 places in Italy
SIRIO BY ZUCCHELE - 1 win & once 3rd placed from 2 strats.
ZARINA BY ZUCCHELE - 1 win & once 2nd placed.

1st Dam: **IAPOMICA** (f, by Bonorvesu) unraced, Dam of:
TORNADO BY ZUCCHELE (c, by Zucchele) **5 wins & 3 places in Italy**
 Ussana (f, by Zucchele) once 4th placed in Italy.
SIRIO BY ZUCCHELE (c, by Zucchele) Subject Horse.

2nd Dam: **ULTANA** (f, by Veinard Al Maury) Dam of:
SIBILLINA (f, by Bonorvesu) **5 wins & 8 places**
 Ussarus (c, by Bonorvesu) twice 3rd places.
 Rasmussem (c, by Al Mogaver Del Menhir) once 4th placed.

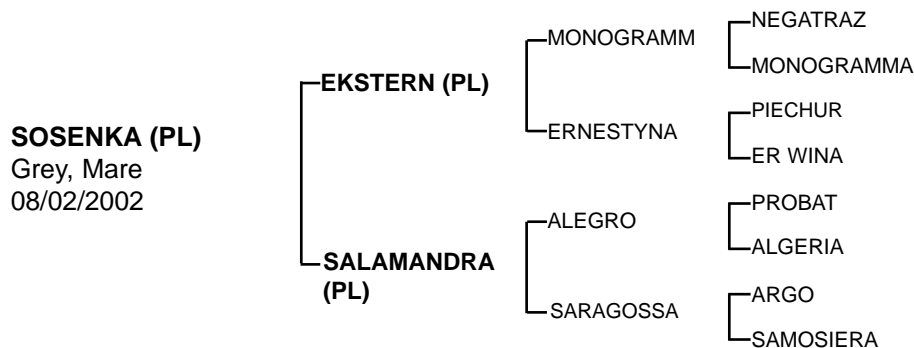
No: **71****SOSENKA** - Dam of:**SAN HASSA** - **Bronze Champion** Senior Female - British Breeders Alliance 2016.Sire: **EKSTERN** (c, by Monogramm) -1995 **Polish National Champion** Colt - Michalow Junior Show/ PL1996 **International Champion** Colt - Babolna International Championships/ HU1999 **International Champion** Stallion - UKIAHS International Championships / UK2000 **International Champion** Stallion - 'Tulip Cup' International Show, Deurne/ NL2000 **Polish National Champion** Stallion - Polish National Show/ PL2000 All Nations Cup **Champion** Stallion - All Nations Cup show / DE (Title show)2000 **European Champion** Stallion - European Championships /DK (Title show)2000 **World Champion** Stallion - World Championships Paris/ FR (Title show)2000 **'Triple Crown' winner** - Champion ANC/EC/World Ch. in the same year2003 Mercedes Diamond Cup **Champion** 'Elran Cup' Int'l Show, Borgloon/ BE2008 WAHO Trophy (Poland) - **Winner** of this annually provided award in a country

Sire of:

ESPARTO is a **multiple International Champion** Stallion and the **Polish National Champion** Stallion, in 2009.**CELSJUSZ** - **Polish National Champion** Colt in 2007**PALANGA** - 2004 **Reserve Champion** Filly, Bialka Junior Spring Show2004 **Polish National Reserve Champion** Filly2006 **European Reserve Champion** Mare, in Moorsele/Belgium2007 **Polish National Reserve Champion** Mare**MYSTERIOUS LADY J** - 2006 **Reserve Champion** Filly, European Championships2010 **Saudi National Champion** Mare, Saudi National Show Jeddah1st Dam: **SALAMANDRA** (f, by Alegro) Dam of:**SZYSZKA** (f, by Ekstern)

1st Mares 12 years & over - Concours Regional 2015

2nd Mares 7-12 years old - Concours Regional 2014

SHAMAAL (c, by Al Maraam)

3rd Old Style (non ECAHO Class) - 8 PS Arabian Bergamo 2020

SYLWAN (c, by Wojslaw)

4th Stallion 7-10 years old - Poznan-Wola Show 2002.

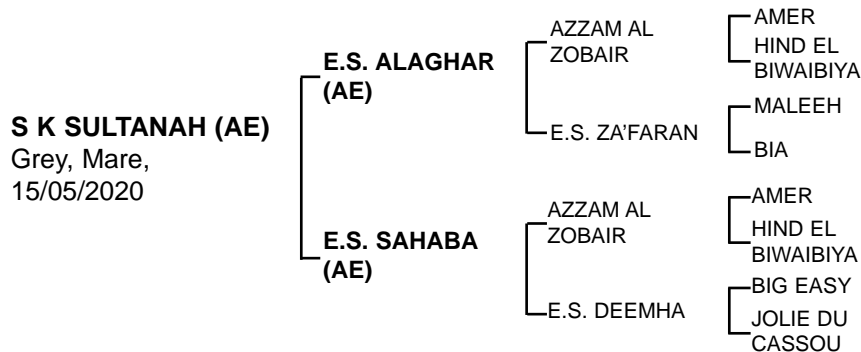
No: **72**

Sire: **E.S. ALAGHAR** (c, by **AZZAM AL ZOBAIR** (c, by Amer) unplaced from 1 start. Her sire **AMER** (c, by Wafi), **5 wins** from 7 starts in UK. Outstanding sire of **winning race horses Sire of 107 winners** of 432 races including **49 Group 1** races around the world. **AL ANOOD -18 wins** (incl: **6 Gr.1** races), **MUTABAHI - 11 wins** (incl: **4 Gr.1**), **DAHES** - **27 wins** (incl: **13 Gr.1** races), **NIZAM - 15 wins** (incl: **4 Gr.1** races), **AL DAHMA - 22 wins** (incl: **15 Gr.1** races), **MUGADIR - 17 wins**, **MAJD AL ARAB - 10 wins** (incl: **5 Gr.1** races), **MUNEEF - 6 wins** (incl: **1 Gr.1** races), **GENERAL - 5 wins** (incl: **1 Gr.1** races), **AL ANQA - 3 wins**, **DAMIS - 2 wins**, **MURHIB - 10 wins** incl: **Gr.2 & Gr.3 winners**, **MALEEHAH - 16 wins** incl: French **1Gr. win**, **OMAIER - 3 wins**, **RAQIYAH - 5 wins** (incl: **Gr.1** races), **TAMEEMAH - 5 wins**, **AL ZUBARAH - 18 wins**, **DARRAB - 8 wins**, **MALIKA AL MAIDA - 6 wins**, **ZREIG - 4 wins**.

1st Dam: **E.S. SAHAB** (f, by **AZZAM AL ZOBAIR** (c, by Amer) unplaced from 1 start. Her sire **AMER** (c, by Wafi), **5 wins** from 7 starts in UK. Outstanding sire of **winning race horses Sire of 107 winners** of 432 races including **49 Group 1** races around the world.

2nd Dam: **E.S. DEEMHA** (f, by Big Easy) 4 places from 7 starts in UAE. Her sire **BIG EASY** (c, by Burning Sand) **23 wins & 15 places** (incl: **6 Gr. wins & 9 Gr** places) from 36 starts in USA & UAE - \$ **445, 232**, **Track Records** in 2001 (Nad Al Sheba Racecourse): Saratoga PA - Conditions 1200m in **01:16:54**, Sire of **many winners** incl: **BURNING FIRESTAR: 6 wins & 16 places** from 24 starts in USA - \$ **102,612**. **ES AJEEB: 4 wins** from 7 starts, **1st Bani Yas (Gr.2)** in UAE, **LATIFA PRINCESS: 5 wins & 2 places**, **ES FATEK: 3 wins & 5 places** in UAE, **ES MAYDAN: 3 wins & 17 places** in UAE, **ES TANGO: 3 wins & once 2nd place** in UAE, **ES ALMAS: 2 wins & 2 places**, **AL HADAF: 1 win & 4 places** in UAE, **KHOUROS CS: 1 win & 12 places** in USA, **AL MOBHER: 1 win & 9 places**.

3rd Dam: **JOLIE DU CASSOU** (f, by Baco du Cassou) 2 places from 5 starts in UAE. Dam of: **ES FNNAN** (c, by Big Easy) **1 win & 3 places**

No: **73**

TA'AIF (FR)
Chestnut, Stallion
23/05/2009

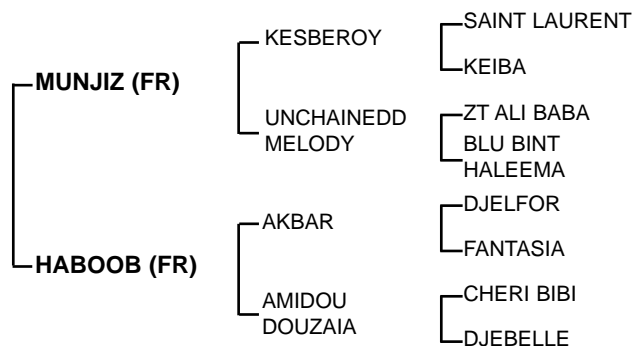

Sire: **MUNJIZ** (c, by Kesberoy) **1 win** & 4 places from 6 starts. **winner** of: Prix du President des Emirats Arabes Unis - Challenge Derby (**Gr.1**), 2nd Prix de Carthage (**Gr.2**), 3rd Prix du Haras de Gelos. **Half brother** to **MIZZNA**, **MIJDADD**. Sire of **winners** incl: **JOSCO DU CAUROU**, **GHALIB**, **SAHLAMBO**, **MUNZADE**, **MYRA DE MONLAU**, **AAKIF**, **AL MAMUN MONLAU**, **AWAM**, **ELYAAH**, **AL BASHTOON**, **MISTER DU LOUP**, **MELK**, **FANTASY MISS**, **LADY WISH**, **MISS FANTASIA**, **MASCATE**, **GHADEER**, **KARLOS DU CAYROU**, **ZAKHO**, **THABIT**, **BANDAR**, **NAJAH**, **YATHRIB**, **MUNOWRA**, **AUSTRALYA**, **SOMOUD**, **ESKANDAR**, **BASEEL**, **DUZAR**, **MUNZADE**, **CANDAHAR**, **MUSHARAF** & many more.

1st Dam: **HABOOB** (f, by Akbar) **1 win** & 2 places. Dam of:

DERYAN (c, by Mahabb) **7 wins** & 10 places, The President of the UAE Cup (**Gr.1**), Qatar Coupe de France des Chevaux Arabes (**Gr.2**), Prix Dormane (**Gr.3**).
SHAHM (c, by Mahabb) **5 wins** & 5 places, 1st The President of the UAE Cup (**Gr.1**), 2nd Qatar Cup (**Gr.1**).
MARZOOQ (c, by Bibi De Carrere) **2 wins** & 3 places, 4th Sh.Zayed bin Sultan Al Nahyan Cup (**Gr.3**).
YATHRIB (f, by Munjiz) **1 win** & 5 places, 3rd Qatar Prix de L'Eleavage (**Gr.2**), Criterium des Pouliches (**Gr.2**).
SANAD (g, by Munjiz) **1 win** & 5 places.

2nd Dam: **AMIDOU DOUZAIA** (f, by Cheri Bibi) **6 wins** & 5 places. Dam of:

MESSINE DE SINUHE (c, by Njewman) **4 wins** & 10 places
DAHWA (f, by Tidjani) **2 wins** & 10 places. Dam of:
THABIT (c, by Munjiz) **4 wins** & 8 places
BANDAR (c, by Munjiz) **3 wins** & 7 places
NAJAH (f, by Munjiz) **2 wins** & 2 places
ARYAAN (f, by Kesberoy) **1 win** & 4 places. Dam of:
NASEEM (c, by Mahabb) **6 wins** & 8 places
ALIAA (f, by Djelfor) **3 wins** & 2 places in UAE. Dam of:
ABHAAR (c, by Al Nasr) **7 wins** & 5 places
FATAT AL ARAB (f, by Al Nasr) **3 wins** & 2 places
MUSTAJEEB (g, by Calin Du Loup) **1 win** & 2 places.
MOWAFAKA (f, by Tidjani) unraced, Dam of:
ELAF (f, by Rabbah De Carrere) **1 win** & 4th Qatar Arabian Trophy (**Gr.1**).
BAYAN (f, by Munjiz) **3 wins** & 4 places. **1st** Hatta International Stakes (**Gr.1**), Qatar Prix de L'Eleavage (**Gr.2**), 2nd Qatar Arabian Trophy (**Gr.1**).
SALAAMAH (f, by Njewman) **3 wins** & 3 places, 1st The Emirates Equestrian Federation Int'l Stakes (**Gr.2**), 2nd Prix Nevada III (**Gr.3**).

No: 74

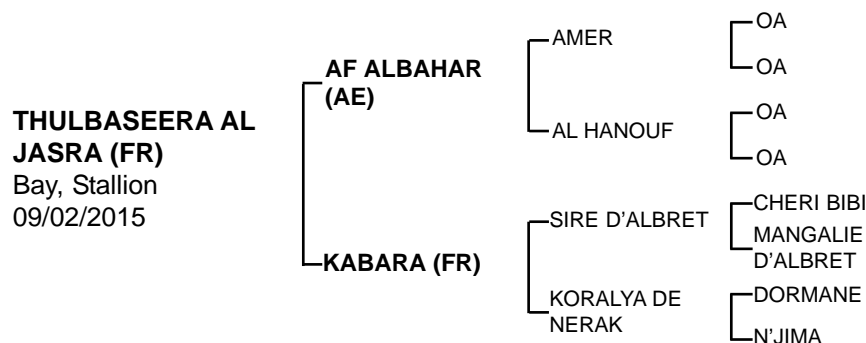
**THULBASEERA AL JASRA - 1 win & 3 places. Official Rating: 45**

Sire: **AF ALBAHAR** (c, by Amer) unraced, **Half Brother** to **AF MABROOKAH** (f, by Djebbel) **5 wins** & 2 places from 7 starts. **HATTEEN** (c, by Bengali d'Albret) **3 wins** & 3 places from 7 starts (**Sire**). **AL HAMDANIYA** (f, by Al Mori) **winner** of The Hilli. Sire of **many winners** incl: **AF MATHMOON - 9 wins** & 2 places from 12 starts, incl: Dubai Kahayla Classic (**Gr.1**), Al Maktoum Challenge (**Gr.1**), Liwa Oasis (**Gr.1**), Bani Yas (**Gr.2**). **JAMRA - 2 wins** & 7 places. **AL MURABITON - 4 wins** from 4 starts. **AJS INTIFADAH - 4 wins** & 6 places. **JENJAL - 2 wins** & twice 2nd place from 4 starts. **BINT JAKKARTA - 2 wins** & 5 places from 7 starts. **SAHABA - 1 win** & 5 places. **AL FAKHAMAH - 1 win** & 3 places. **AIN JALOUT - 4 wins** & 4 time 2nd placed. **ALSAKER - 4 wins** & 2 places from 6 starts in France & many more.

1st Dam: **KABARA** (f, by Sire D'Albret) unplaced, **Half Sister** to **MUSHARAB**. Dam of:

RAYANAH ALJASRA (f, by Munjiz) **1 win** & 2 places
DA'AS (c, by Majd Al Arab) **winner** in Poland.
THULBASEERA AL JASRA (c, by AF Albahar) **Subject Horse**.

2nd Dam: **KORALYA DE NERAK** (f, by Dormane), Dam of:

MUSHARAB (c, by Njewman) **5 wins** & 13 places, **1st** Emirates Championship (**Gr.1**) (**X2**), 2nd Liwa Oasis (**Gr.1**), Prix Cheri Bibi (**Gr.2**), 3rd Dubai Kahayla Classic (**Gr.1**), Coupe de France des Chevaux Arabes (**Gr.1**).
DUZAR (c, by Munjiz) **2 wins** & 11 places.
GHALEBA (f, by Munjiz) **1 win** & once 4th placed.
RAKEED (c, by Mahabb) **winner** in France.
Aleen (f, by Sarrab) 3rd French Arabian Breeders Challenge (**Gr.2**)
Ammira (f, by Akbar) 5 places from 6 starts.
Daanah (f, by Munjiz) 8 places from 10 starts.
Fayied (c, by Tidjani) 11 places in Qatar.

3rd Dam: **N'JIMA** (f, by El Afrit) unplaced, **Half Sister** to **EL ALYA** (f, by Jassem) **2 wins** & 10 places - Broodmare, **HISSAOUIYA** (f, by Jassem) **1 win** & 12 places - Broodmare, **YAGOURI** (c, by Kesberoy) **3 wins** & 11 places. Dam of:

KAN'JI DE NERAK (Racing Name **NISSR AL JAZIRA** c, by Manganate)
1 win & 4 places.

No: 75

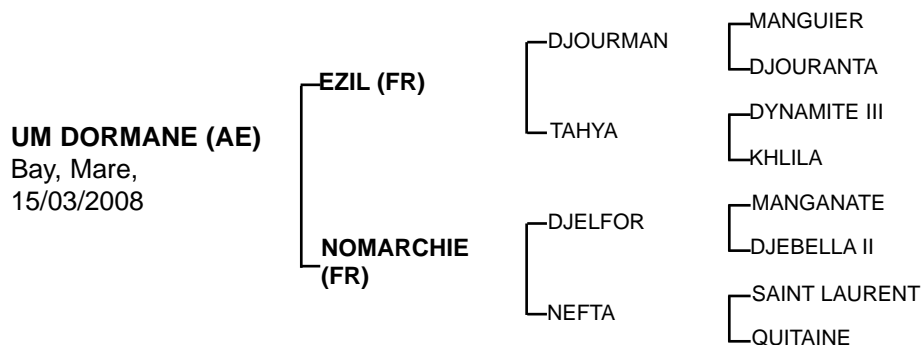

UM DORMANE - 1 win & 2 places.

Sire: **EZIL** (c, by Djourman) **19 wins**, 10 time 2nd, 3rd (twice) & 3 places in UAE. winning incl: **1st** National Day Cup (1600 - **Gr.3**), Emirates Championship (2200 - **Gr.1**), HH The President Cup (2200 - **Gr.1**)(twice), Sh Maktoum bin Rashid Al Maktoum Challenge Round III (2000 - **Gr1**), 2nd Emaar The Dubai Arabian Classic (2000 - **Gr1**), Emirates Championship (2200 - **Gr.2**), HH The President Cup (2200 - **Gr1**).sire of **many winners**. Half Brother to **GERBYA, SAMBAA**.

1st Dam: **NOMARCHIE** - 3 wins & 9 places, Dam of:

SHARAF AL REEF (c, by Bibi De Carrere) **6 wins** & 18 places, **1st** Liwa Oasis (**Gr.2**), Sh.Zayed bin Sulatn Al Nahyan Cup (**Gr.3**), 2nd Sh. Zayed bin Sultan Al Nahyan National Day (**Gr.3**).

NAWARAT AL REEF (f, by Bibi De Carrere) **3 wins** & 7 places

WARDA AL REEF (f, by Kalbarq) **1 win** & 1 placed

2nd Dam: **NEFTA** (f, by Saint Laurent) unraced, Dam of **winners** incl:

NUITS ST GEORGES (c, by Dunixi) **2 wins** & 2 places - **Sire**

Jaffa Du Berlais (f, by Baj) 4 places from 7 starts. Dam of:

HAMTARA (c, by Dormane) **4 wins** & 19 places - **Sire**

CHAIKH MAN (c, by Dormane) **6 wins** & 6 places - **Sire**

ABITIBI (c, by Cheri Bibi) **4 wins** & 17 places - **Sire**

POM DU BERLAIS (f, by Manganate) **3 wins** & 12 places

Ne Rien Faire (f, by Nadji) unraced, Dam of **winners** incl:

HAMID (c, by Djelfor) **5 wins** & 2 places from 7 starts

SAADI DES BERGES (c, by Djelfor) **2 wins** & 5 places

NEWDAY (c, by Djelfor) **4 wins** & 3 places - **Sire**

NE RIEN PRENDRE (c, by Djelfor) **4 wins** & 5 places

NOBLE DAME (f, by Nadji) **1 win** & 3 places, Dam of **winners** including:

NOBLE ATHLETE (c, by Darwan du Cayrou) **6 wins** & 14 places

NOBLE DESIR (g, by Dormane) **2 wins** & 5 places

NOBLE LIGNEE (c, by Kesberoy) **2 wins** & 3 places

NARDE CELTIQUE (f, by Djelfor) **1 win** & 3 places, Dam of:

NAJD (c, by Darike) **2 wins** & 2 places

NACHOR (g, by Djelfor) **3 wins** & 5 places

NOUILLAUGRATIN (f, by Dunixi) **1 win** & 5 places, Dam of:

VOLAUVENT (c, by Dormane) **3 wins** & 6 places - **SIRE**

SPAGHETTI (c, by Snoopi) **3 wins** & 2 places.

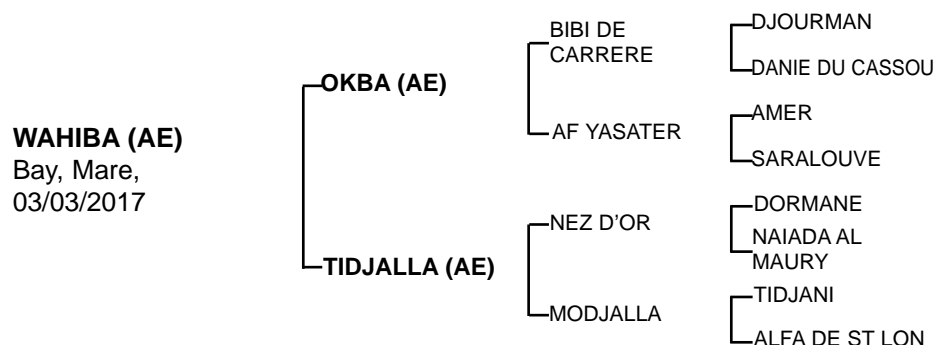
No: **76**

Sire: **OKBA** (c, by Bibi De Carrere) **3 wins** & 4 places, **FULL Brother** to **SABBAQ - 2 wins** & 5 places, **SARAB AL REEF - 3 wins** & 2 places, **SATAAR AL REEF - 2 wins** & 11 places. His sire **BIBI DE CARRERE** (c, by Djourman) **8 wins** and 6 places from 17 starts at 3- 5yo in France & UAE, Sire of **many winners** incl: **RABBAH DE CARRERE - 5 wins** & 5 places, **DYNAMITE - 10 wins** & 23 places - The First Local bred in the History of Arabian Racing to winner of HH The President Cup (**Gr.1**), **NAHEE - 4 wins** & 4 places, **CARAT - 4 wins** & 8 places, **SHA'RED - 2 wins** & 5 places, **SAKEN - 8 wins** & 6 places, **MARZOOQ - 2 wins** & 1 place, **RS KERIM - 6 wins** & 3 places, & among others.

1st Dam: **TIDJALLA** (f, by Nez D'Or) unraced from 1 start. Her sire Her sire **NEZ D'OR** (c, by Dormane) **6 wins** & 10 places from 16 starts in UAE, **Top rated 127**. **1st** Dubai Kahayla Classic (**Gr.1**), Sh.Maktoum bin Rashid Al Maktoum Challenge Round II (**Gr.1**), Sh Maktoum bin Rashid Al Maktoum Challenge Round I (**Gr.1**), HH Sheikh Khalifa bin Zayed Al Nahyan Triple Crown Round III (**Gr.1**), HH Sh Khalifa bin Zayed Al Nahyan Triple Crown Round I (**Gr.3**), Al Asayl Championship (**Gr.3**), 2nd Dubai Kahayla Classic (**Gr.1**), Sh Maktoum bin Rashid Al Maktoum Challenge Round III (**Gr.1**). Sire of **many**, incl: **JINAD, BINT SHAGRA III, DAHDAH, MARAM, MESHWAR, NASEEM AL REEF, RAGDAN, VICTOR ADAM, KNIFE, MARAM** & more.

2nd Dam: **MODJALLA** (f, by Tidjani) unraced, Dam of **winners** incl:
MUJTAHID (c, by Saklawi Jadrane) **2 wins** & 1 place
MUDALLAL AL REEF (c, by Saklawi Jadrane) **3 wins** & 4 places

3rd Dam: **ALFA DE ST LON** (f, by Djouras Tu) unraced, Dam of :
MOSHAKIS (g, by Tidjani) **1 win** & 6 places
MUNIKI (c, by Tidjani) 1 win & 7 places
KEHEILAN (f, by Kesberoy) 6 places. Dam of **winners** incl:
AGHAREED AL KHALEDIAH (f, by Jalood Al Khalediah) **1 win** & 5 places
GHADAN AL KHALEDIAH (c, by Jalood Al Khalediah) **2 wins** & 2 places
BASEQ AL KHALEDIAH (c, by Tiwaiq) **1 win** & once 2nd place

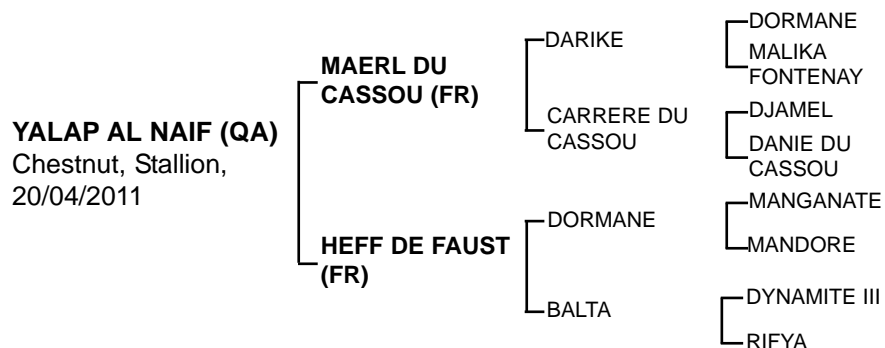
No: **77****YALAP AL NAIF - 4 wins & 8 places, OFFICIAL RATING: 40**

Sire: **MAERL DU CASSOU** (c, by Darike) **5 wins** & 2 places from 8 starts in Qatar. **Full Brother** to **LEIK DU CASSOU** - **1 win** & 2 places, **Half Brother** to **PANAME DU CASSOU** - **3 wins** & 7 places, **JUNIOR DU CASSOU** - **2 wins**, **TITI DU CASSOU** - **1 win** & 1 place, **FEE DU CASSOU** - **3 wins** & 11 places. Sire of **winners** incl: **JOURAAS AL NAIF** - **winner** in Qatar, **BESHER AL NAIF** - **2 wins** & 12 places

1st Dam: **HEFF DE FAUST** (f, by Dormane) 3 places from 3 starts in Qatar. Her sire **DORMANE** (c, by Manganate) raced as a 3 & 4 year old and had **6 wins**. He is own brother to **DJAMEL**, **MADJEL**, **DJENBEL** and **MARGAU** dam of **MASSAMARIE**. **DORMANE** is the championship sire of his generation and is sire of **winners** including, **DORMAN DU CAYROU**, **PASSEM LOTOIS**, **DARIKE**, **CHNDAKA**, **CHAIKH MAN**, **NOREEN**, **NISAE**

2nd Dam: **BALTA** (f, by Dynamite III) Dam of **winners** incl:
HAUT DE FAUST (c, by Barour de Cardonne) **6 wins** & 21 places.
PIERRE DE FAUST (c, by Dormane) **3 wins** & 3 places
REBELLE DE FAUST (c, by Prince d'Orient) **1 win** & 5 places
 Hedith de Faust (f, by Tornado de Syrah) 1 place from 1 start. Dam of:
JOURAAS AL NAIF (c, by Maerl du Cassou) **1 win** & 16 places

No:78

H.YAMANI (AE)
 Bay, Stallion
 02/02/2018

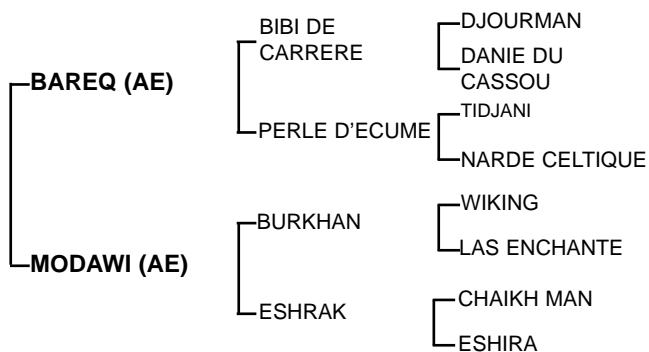

Sire: **BAREQ** (c, by Bibi De Carrere) **5 wins** & 24 places, 2nd Arabian Triple Crown R2 (**Gr.3**), 3rd Abu Dhabi Triple Crown R3 (**Gr.3**). Half Brother to ETIHAD - **1 win** & 2 placed. His sire **BIBI DE CARRERE** (c, by Djourman) **8 wins** and 6 places from 17 starts at 3- 5yo in France & UAE, Sire of **many winners** incl: **RABBAH DE CARRERE** - **5 wins** & 5 places, **DYNAMITE** - **10 wins** & 23 places - The First Local bred in the History of Arabian Racing to winner of HH The President Cup (**Gr.1**), **NAHEE** - **4 wins** & 4 places, **CARAT** - **4 wins** & 8 places, **SHA'RED** - **2 wins** & 5 places, **MARZOOQ** - **2 wins** & 1 place, **RS KERIM** - **6 wins** & 3 places, **SAKEN** - **8 wins** & 6 places & among others.

1st Dam: **MODAWI** (f, by Burkhan)

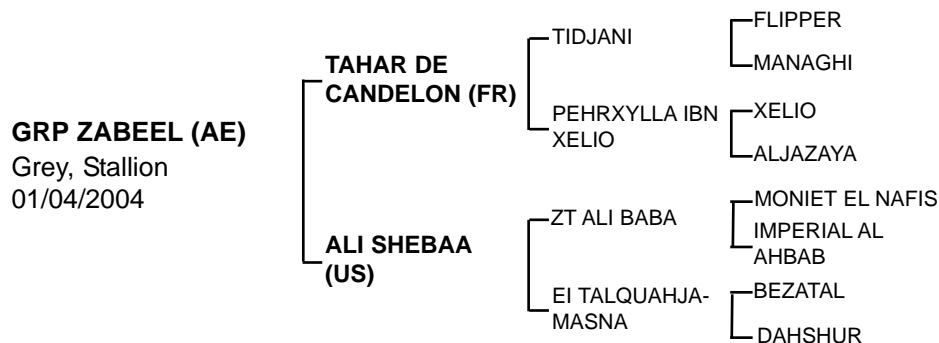
No: **79**

GRP ZABEEL - 8 places in UAE. Finish 2x 40km Qualifier, 2x 80km Qualifier & CEI1* 80

Sire: **TAHAR DE CANDELON** (c, by Tidjani) **6 win** and 1 placed from 7 starts. Earned **Prize Money** more than **287,000.00 A.E.D.** **winner** of: **1st** Sh. Maktoum Bin Rashid Al Maktoum Challenge Round III, Sh. Maktoum Bin Rashid Al Maktoum Challenge Round II & Abu Dhabi Duty Free Gold Cup. sire of many **winners** incl: **LAHAB, DANGER, MAKED, THICK, MANSUR, RAFED, GRP ROMA GHANTOOT, HAZEM, CENTURION, CHESSMAN, ALAMA, MAHABB** & many more. Great sire line.

1st Dam: **ALI SHEBAA** (f, by ZT Ali Baba) 7 places from 11 starts in USA. Dam of:
JUMEIRA (f, by Monarch AH) **2 wins** & 17 places in USA. Dam of:
INDIGENA (f, by Line Dancer) **4 wins** & 21 places
 GRP Lolita Ghantoot) 5 places in UAE
 Private Dancer (f, by Aneto) 4 places from 4 starts
 Adoniz (c, by Ala Croixnoire) 5 places from 5 starts

Her sire **ZT ALI BABA** - was a **stakes winner, sire** race horses who **won** over **\$1.4 million** on th track. Some of his daughters the famous **Victorias Secrett 14(14-0-0)**, **\$180,777** in US, **3(3-0-0)** in UAE, and the **Darley Champion** and horse of the year **Unchained Melody 7(7-0-0)4**, **\$94,040**. Other **ZT Ali Baba** have produced incredible **winners** includin **Mr Full Service 64 (17-16-15) 6-17 \$311,717**, **Dixie Dariene 40 (17-10-4)8-9 \$ 281,689**.

No:80

ZAHEED (FR)
Bay, Stallion,
12/02/2014

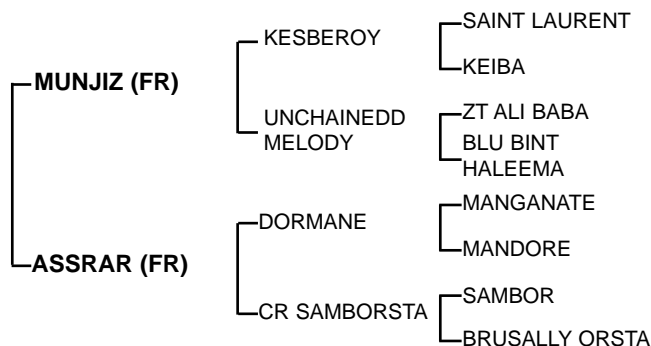

Sire: **MUNJIZ** (c, by Kesberoy) **1 win** & 4 places from 6 starts. **winner** of: Prix du President des Emirats Arabes Unis - Challenge Derby (**Gr.1**), 2nd Prix de Carthage (**Gr.2**), 3rd Prix du Haras de Gelos. **Half brother** to **MIZZNA**, **MIJDADD**. Sire of **winners** incl: **JOSCO DU CAUROU**, **GHALIB**, **SAHLAMBO**, **MUNZADE**, **MYRA DE MONLAU**, **AAKIF**, **AL MAMUN MONLAU**, **AWAM**, **ELYAAH**, **AL BASHTOON**, **MISTER DU LOUP**, **MELK**, **FANTASY MISS**, **LADY WISH**, **MISS FANTASIA**, **MASCATE**, **GHADEER**, **KARLOS DU CAYROU**, **ZAKHO**, **THABIT**, **BANDAR**, **NAJAH**, **YATHRIB**, **MUNOWRA**, **AUSTRALYA**, **SOMOUD**, **ESKANDAR**, **BASEEL**, **DUZAR**, **MUNZADE**, **CANDAHAR**, **MUSHARAF** & many more.

1st Dam: **ASSRAR** (f, by Dormane) **2 wins** & 1 place from 3 starts. Dam of:
BASEEL (f, by Munjiz) **3 wins** & 1 placed from 4 starts in France. incl: Prix Nevada II (**Gr.3**), Prix Razzia III (**Gr.3**), 3rd Qatar Arabian Trophy des Pouliches (**Gr.1**).
HAMARES (c, by Bibi De Carrere) **2 wins** & 11 places.
ASLAAN (c, by Bibi De Carrere) **4 wins** & 10 places, 4th Mazrat Al Ruwayah (**Gr.2**)

2nd Dam: **CR SAMBORSTA** (f, by Sambor) **7 wins** & 3 places from 11 starts, Incl:
1st AJC Debutante Handicap, AJC Delaware Stakes, Delaware Arabian Cup Juvenile Fillies, Fire Cracker Futurity VI, Korona Arabian Cup Juvenile Fillies, 2nd AJC California Stakes, Dam of **winners** incl:
SABEAR (f, by Dormane) **5 wins** & 14 places
SARRAB (c, by Tidjani) **9 wins** & 12 places
DARIYA (c, by Dormane) **8 wins** & 8 places
SAHER (g, by Tornado de Syrah) **2 wins** & 7 places
SAHLAMBO (f, by Munjiz) **7 wins** & 6 places
SYRIANAH (f, by Dormane) **3 wins** & 8 places
SAMJIDA (f, by Majd Al Arab) **2 wins** & 5 places
HERCEY SEINE (c, by Majd Al Arab) **1 win** & 1 place from 3 starts.
MANNAR (f, by Djelfor) unraced. Dam of:
MARAM (c, by Nez d'Or) **3 wins** & 8 places
Shahranaz (f, by Scharly) unraced, Dam of:
MUSHAIRIB (c, by Calin du Loup) **1 win** & 5 places from 7 starts.

No:81

ZAKHER (AE)
Grey, Stallion
14/02/2013

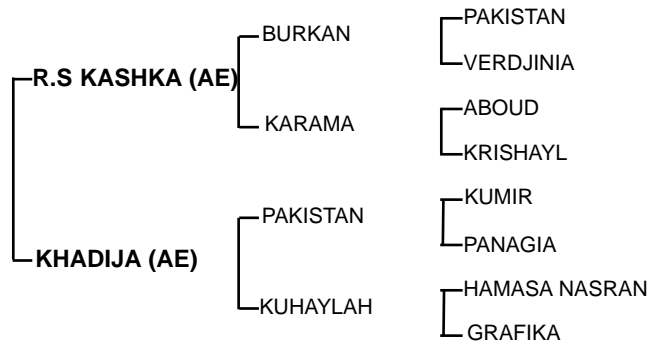

Sire: **R.S KASHKA** (c, by Burkan).

1st Dam: **KHADIJA** (f, by Pakistan).

No:82

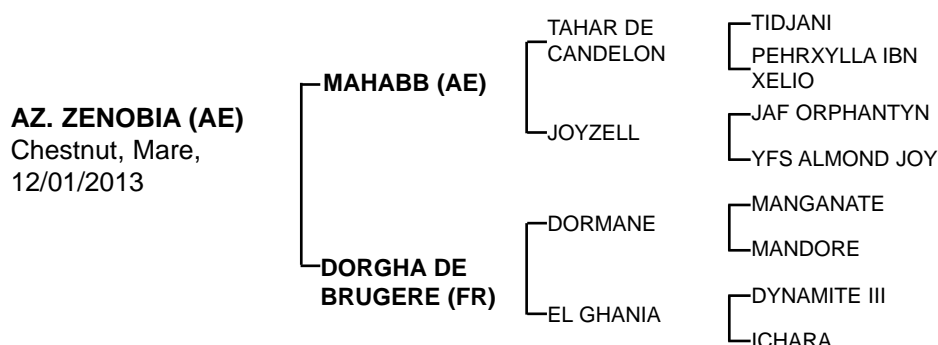
**AZ. ZENOBIA** - once 3rd placed, **OFFICIAL RATING: 37**

Sire: **MAHABB** (c, by Tahar de Candelon) 8 races, **5 wins** & 3 places at 4-5 in France & England - **\$41,071**, winning incl: **1st Prix Nefta (Gr.2)**, **1st Prix Damas (Gr.3)**, 2nd The Zaabeel International Stakes (**Gr.1**)(X2), 3rd French Arabian Breeder's Cup Mile (**Gr.1**) - **1200mtr record 1:16**, Sire of **many winners** incl: **MANARK, FAZAH, SARDAN, REKHA, MESTOR, AREEM SHATEH, AF HASBA, AF TATHOOR, TAYMOUR, JOORI, AF MO'ASSESS, ROCKMANE, SAUTERNES AL MAURY, MEYDAN DU PAON, THAKIF, CHALWA DU PAON, SHAHM, NASEEM, VISIONARY LADY** & many more.

1st Dam: **DORGHA DE BRUGERE** (f, by Dormane), 6 place in france, winnings incl: **2nd Prix Du Grand Garage De Gascogne**, Castera-Verduzan: 4th Prix Des Ecuries Royales, Toulouse; 5th Prix Djourman, Toulouse; 5th Prix Razzia III, Dax; 5th Prix Kann, Mont-De-Marsan. Her **Sire: DORMANE** (c, by Manganate), Bred in France. He raced as a 3 and 4 year old and had **six wins**. He is own brother to **DJAMEL, MADJEL, DJENBEL**, and **MARGAU** dam of **MASSAMARIE**. **DORMANE** is the **championship sire** of his generation and is sire of **winners** including, **DORWAN DU CAYROU, PASSEM LOTOIS, DARIKE, CHNDAKA, CHAIKH MAN, NOREEN, NISAE**. Dam of:
AZ Shamah (f, by Dahess) 3 places, 4th Arabian Triple Crown R3 (**Gr.3**).

2nd Dam: **EL GHANIA** (f, by Dynamite III) **8 wins** & 10 places from 3 to 5 years in Tunisia. Incl: Prix du Haras de Tiaret, Prix Aziza Othmana, Prix du Caire, Prix Taha Assein, Prix de la Municipalité, Prix Ismail Bouguerra. **FULL SISTER** to **AKERMI** - **39 wins** & 6 places from 46 Start, Incl: Prix d'Essai des Poulains (**Gr.1**) Critérium des 2 ans (**Gr.1**) , Port Saïd (**Gr.3**) De l'Ariana (**Gr.3**). In 1990 **winner** of Grand Prix du Président de la République (**Gr.1**) , Grand Prix du Ministère de l'Agriculture (**Gr.1**) , Grand Prix du Conseil Municipal (**Gr.1**). Dam of:
MANGHO DE BRUGERE (c, by Dormane) **8 wins** & 13 places

No:83

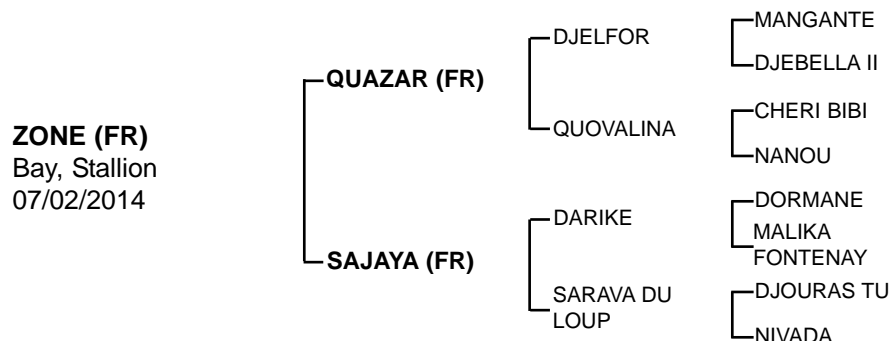

ZONE - 2 places from 5 starts. OFFICIAL RATING: 44

Sire: QUAZAR (c. by Djelfor) **3 wins** & 1 place from 4 starts, incl: Abu Dhabi Int'l Championship (Gr.1) & Prix d'Abu Dhabi (Gr.1). Sire of **HAANOOF - 4 wins** & 12 places. SAARAH - 1 win & 6 places, **Half Brother** to **VERMILLON - 10 wins**, **VENT DREDY - 5wins**. **VERDOYANTE - 2 wins**, **VERT TIGE - 2 wins**, **VERLINO - 10 wins**.

1st Dam: **SAJAYA** (f, by **DARIKE** (c, by Dormane) **9 wins** & 13 places in France & UAE. Sire of **many winners** incl: **MOKA D'OR, LEIK DU CASSOU, HACHE DEUX EAUX, EAU DE ROCHE, DARIKAN, DARHA, DADJI, AU VOL DEL SOL, AKIM DU LOUP, MALIK DU POUY, MAERL DU CASSOU, BEN JACK, PRINCE AMIN, JEUNE MARIE, RAINBOW DE FAUST, BANJO DU LOUP, JOUEUR DU LOUP, ZAIN AL MAANI, KALIKEAUBA, SHAIK, SEEF, DARIKOU, ANOOD AL GHAI, SAMA BU DHABI, MAHARANI** & many more).

2nd Dam: **SARAVA DU LOUP** (c, by Djouras Tu) unplaced. Dam of:

FRERE DES LOUP (c, by Dunixi) **3 wins** from 5 starts

DENT DE LOUP (g, by Blaise) **9 wins** & 31 places

CROC DE LOUP (c, by Blaise) **2 wins** & 7 places.

Thumb Print (f, by Barour De Cardonne) 2 places from 3 starts, Dam of:

VALIANT BOY (c, by Darweesh) **12 wins** & 9 places, **1st** President of the UAE Cup Stakes (Gr.1) (2013,2014), Delaware Park Arabian Classic Handicap (Gr.1), Valour Farm Arabian Stakes (Gr.2), Bob Magness Memorial Arabian Derby (Gr.2), 2nd Dubai Kahayla Classic (Gr.1).

3rd Dam: **NIVADA** (f, by Flipper) **2 wins** & 7 places Dam of:

SOPHIE DU LOUP (f, by Manganate) **10 wins** & 2 places. Dam of:

MUNTALIQ (c, by Izentespeshal) **2 wins** & 1 place

NEVADA DU LOUP (f, by Manganate) **3 wins** & 1 placed, Dam of:

SHAMEKHA (f, by Vadeer) **2 wins** & 15 places

NEMRAH (f, by Bibi de Carrere) **2 wins** & once 3rd place

SALIA DU LOUP (f, by Manganate) **1 wins** & 3 places. Dam of:

AKIM DU LOUP (c, by Darike) **1 win** & place

MAGIC DU LOUP (g, by Al Sakbe) **1 win** & 5 places

FAKIR DU LOUP (c, by Manganate) **2 wins** in UK

VANESSA DU LOUP (f, by Manganate) **California Champion Mare 20(4-8-5-2)**

2-9). Dam of **winner** incl:

THOROUGHBRED (c, by TC Tomtyr) **11 wins** & 17 places

SILVERRADO (c, by TC Tomtyr) **7 wins** & 21 places.

No:84

AALIA (UAE)
Bay, Mare
12/02/2014

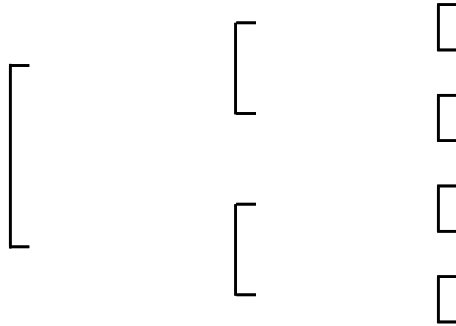

FEI / EEF PASSPORT

No:85

ABEDUL (URU)
Grey, Gelding
2007



FEI / EEF PASSPORT

No:86

ABU HESHAM (UAE)
Bay, Gelding
2002



FEI / EEF PASSPORT

No: **87**

DL ACTITUD (URU)
Bay, Gelding
2007



FEI / EEF PASSPORT

No:88

AKDAL (UAE)
Grey, Gelding
1997



FEI / EEF PASSPORT

No:89

AL ANOOD II (UAE)
Bay, Mare
2002



FEI / EEF PASSPORT

No:90

AL BARQ RG (UAE)
Bay, Stallion
2010



FEI / EEF PASSPORT

No:91

AL FOAA (UAE)
Grey, Mare
04/10/2013

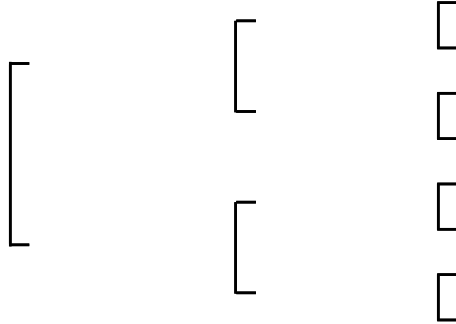

FEI / EEF PASSPORT

No:92

AL JAMAAL TASWAN
(RSA) Grey, Gelding
2004



FEI / EEF PASSPORT

No:93

AL MAGAM (UAE)
Bay, Stallion
21/09/2014

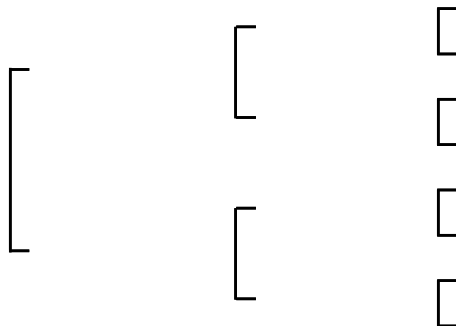

FEI / EEF PASSPORT

No:94

PG AL MASSOUDI
(UAE) Grey, Mare
17/09/2012

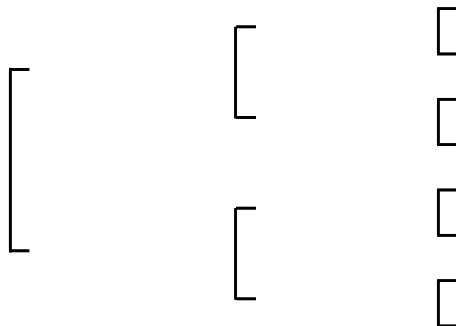

FEI / EEF PASSPORT

No:95

AL WATHBAH (UAE)
Chestnut, Mare
22/10/2014

[[[
	[[
	[[
	[[

FEI / EEF PASSPORT

No:96

AL ZAEEM 1 (UAE)
Bay, Stallion
2002



FEI / EEF PASSPORT

No:97

AL ZAEM ONE (UAE)
Chestnut, Gelding
1990



FEI / EEF PASSPORT

No: **98**

ARAX AMIR (ESP)
Chestnut, Gelding
2011

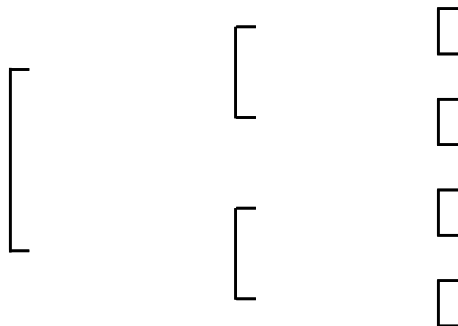

FEI / EEF PASSPORT

No:99

BARAKA BIENVENIDA
(URU) Bay, Mare
18/09/2006



FEI / EEF PASSPORT

No:100

BARAKA PRODIGIO
(URU) Bay, Gelding
12/12/2007



FEI / EEF PASSPORT

No:101

**BEACONFIELD
CONCORD (RSA)**
Bay, Gelding
19/11/2008



FEI / EEF PASSPORT

No:102

BICHO FEO (URU)
Grey, Gelding
02/08/2009



FEI / EEF PASSPORT

No:103

**BREMERSVALE COLD
CHISEL (AUS)**
Chestnut, Gelding
07/02/2010



FEI / EEF PASSPORT

No:104

**CAMP FIRE STORY
(AUS)**
Chestnut, Gelding
29/09/1994



FEI / EEF PASSPORT

No:105

CARINOSA (ESP)
Grey, Mare
15/05/2006

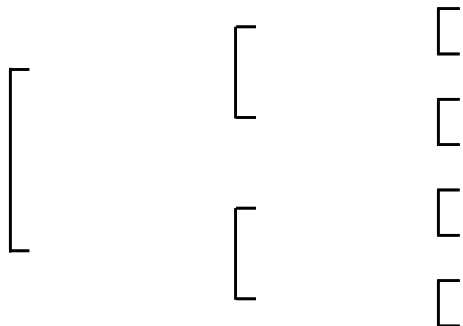

FEI / EEF PASSPORT

No:106

COIMBRA D'IBERICA
(ESP) Grey, Mare
05/04/2007

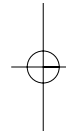
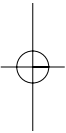

FEI / EEF PASSPORT

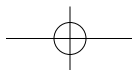

No:107

**CORRYONG COLD
SNAP (AUS)**
Grey, Gelding
29/10/2005



FEI / EEF PASSPORT

No:108

COSACO REAL (URU)
Bay, Gelding
2010



FEI / EEF PASSPORT

No:109

DAHEEMA RG (UAE)
Grey, Mare
2003



FEI / EEF PASSPORT

No:110

DARKA DOS CONDES
(ESP) Grey, Mare
21/03/2008



FEI / EEF PASSPORT

No:111

DEFINITION (UAE)
Bay, Gelding
2010

[

[

[

[

[

[

[

FEI / EEF PASSPORT

No:112

ESCOCIA D'IBERICA
(POR) Grey, Mare
2009

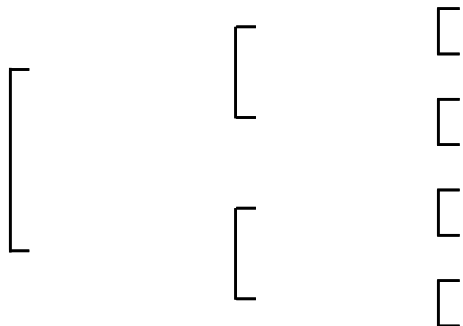

FEI / EEF PASSPORT

No:113

EVORA DA IBERICA
(POR) Chestnut, Mare
2009

[

[

[

[

[

[

[

FEI / EEF PASSPORT

No:114

ZT FAA MAGKHOR
(ARG) Grey, Gelding
2006



FEI / EEF PASSPORT

No:115

FAKHER I (UAE)
Grey, Gelding
1998



FEI / EEF PASSPORT

No:116

P.G FARIDA (UAE)
Bay, Mare
07/09/2019



FEI / EEF PASSPORT

No:117

FARQ BATMAN (UAE)
Bay, Gelding
2010



FEI / EEF PASSPORT

No:118

**FIGARO DEL REPARO
(ARG)**
Chestnut, Gelding
2009



FEI / EEF PASSPORT

No:119

PG HAFEET (UAE)
Grey, Stallion
08/03/2011

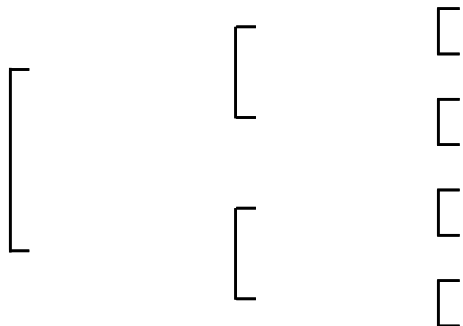

FEI / EEF PASSPORT

No:120

HARGAN (UAE)
Chestnut, Stallion
2002

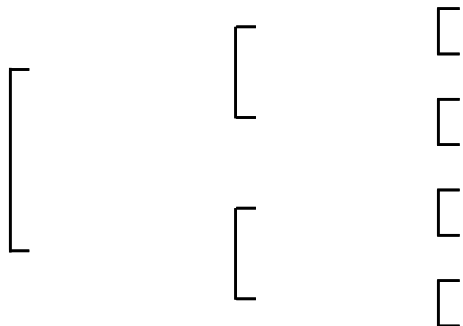

FEI / EEF PASSPORT

No:121

HAROON 1 (UAE)
Grey, Stallion
2002



FEI / EEF PASSPORT

No:122

EF HEROICO (URU)
Bay, Gelding
01/12/2007



FEI / EEF PASSPORT

No:123

**HYFORCE SFW
JACKO LANTERN
(AUS) Grey, Gelding
2014**



FEI / EEF PASSPORT

No:124

INDIANA (ESP)
Bay, Mare
13/05/2008

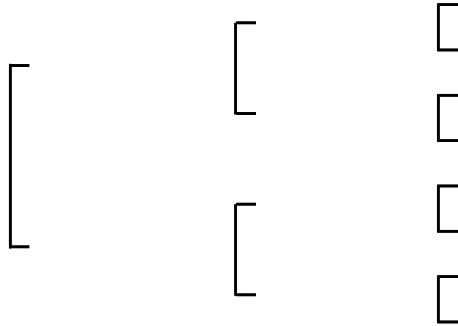

FEI / EEF PASSPORT

No:125

JEJE (URU)
Bay, Gelding
2010

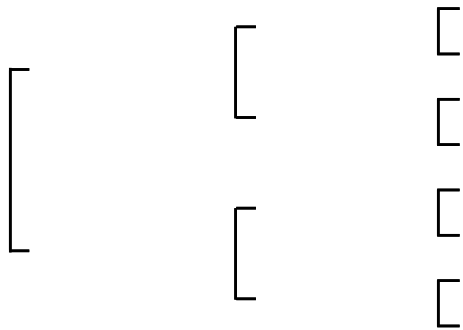

FEI / EEF PASSPORT

No:126

KENAN I (UAE)
Grey, Gelding
1999

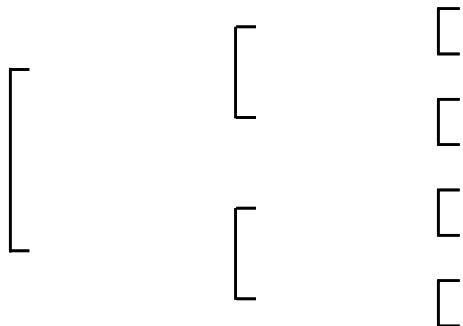

FEI / EEF PASSPORT

No:127

KHAFEEF (UAE)
Grey, Stallion
2009



FEI / EEF PASSPORT

No:128

KHANJER (UAE)
Bay, Stallion
2010

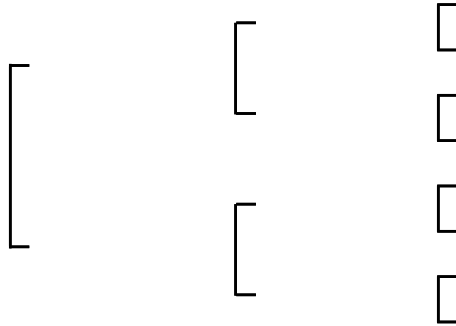

FEI / EEF PASSPORT

No:129

LAFIH (UAE)
Grey, Stallion
21/08/2016

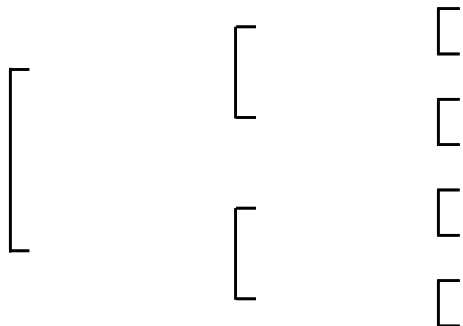

FEI / EEF PASSPORT

No:130

**LLEBRA DE
MASFERRER (ESP)**
Bay, Mare
14/04/2008

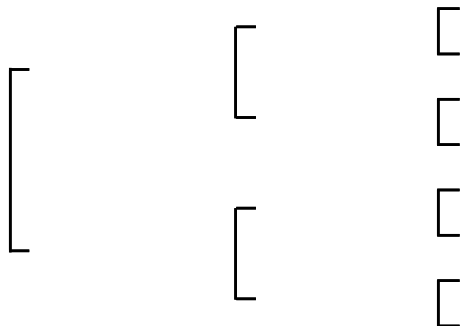

FEI / EEF PASSPORT

No:131

MARSY AL KHEER
(UAE) Bay, Mare
2004



FEI / EEF PASSPORT

No:132

MAZOFA (UAE)
Chestnut, Mare
2009

[

[

[

[

[

[

[

FEI / EEF PASSPORT

No:133

MERJAN RG (UAE)
Chestnut, Stallion
2009



FEI / EEF PASSPORT

No:134

MESSINA (ESP)
Bay, Mare
2010



FEI / EEF PASSPORT

No:135

MOHAJER (UAE)
Grey, Stallion
2007



FEI / EEF PASSPORT

No:136

MUJAHID (UAE)
Chestnut, Stallion
08/07/2016



FEI / EEF PASSPORT

No:137

NASHWA (UAE)
Grey, Mare
1997

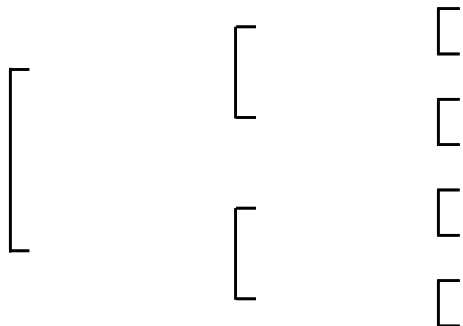

FEI / EEF PASSPORT

No: **138**

RANJEN HAYLEY
(AUS) Bay, Mare
01/08/2010



FEI / EEF PASSPORT

No:139

SAFWOOD PJ VAAN
(UAE) Grey, Gelding
2010

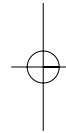
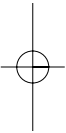

FEI / EEF PASSPORT

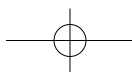

No:140

SHAHWAN (UAE)
Bay, Stallion
2002

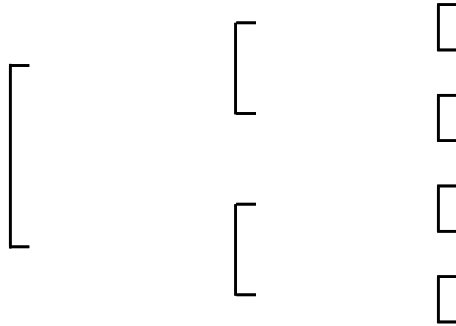

FEI / EEF PASSPORT

No:141

SHAIKHA (UAE)
Bay, Mare
2018

[

[

[

[

[

[

[

FEI / EEF PASSPORT

No:142

**SHAPRISURE
DANCER (RSA)**
Chestnut, Gelding
10/11/2007

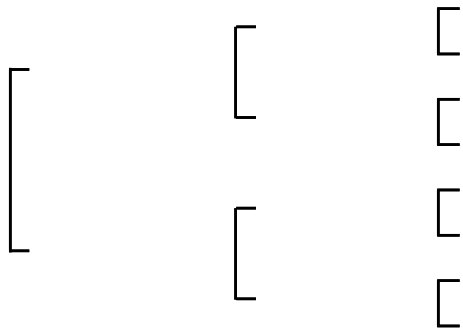

23/11/2019
13/12/2019
28/12/2019
25/01/2020
15/01/2021

CEN 100KM
Qualifier 80KM
CEN 120KM
CEN 100KM
CEN 100KM

Wathba
Bouthib
Dubai
Wathba
Wathba

FEI / EEF PASSPORT

No:143

SHARIF BIN SHARAN
(URU) Grey, Gelding
2009



FEI / EEF PASSPORT

No:144

**SPRINGRIDGE
PHOENIX (AUS)**
Grey, Gelding
01/08/2011



FEI / EEF PASSPORT

No:145

STARDUST RASHER
(RSA) Grey, Gelding
02/10/2004



FEI / EEF PASSPORT

No:146

TOSCANA (URU)
Bay, Mare
01/12/2007

[[[
		[
	[[
		[

FEI / EEF PASSPORT

No:147

UMGHAF A (UAE)
Chestnut, Mare
20/09/2013

[[[
	[[
	[[
	[[

FEI / EEF PASSPORT

No:148

RAS VENTAJA (ARG)
Bay, Mare
15/11/2008

[[[
	[[
	[[
	[[

FEI / EEF PASSPORT

No:149

EM VIRARO (URU)
Bay, Gelding
2010



FEI / EEF PASSPORT

No:150

WAZIER (UAE)
Grey, Gelding
1997



FEI / EEF PASSPORT